

Original Manual
of
Protection-System E16x352
with
Overspeed Protection
and
Voters for external Trip Release Conditions

Certified by TÜV for
IEC61508; SIL3
DIN EN ISO 13849-1:2008; Cat.3 PLe

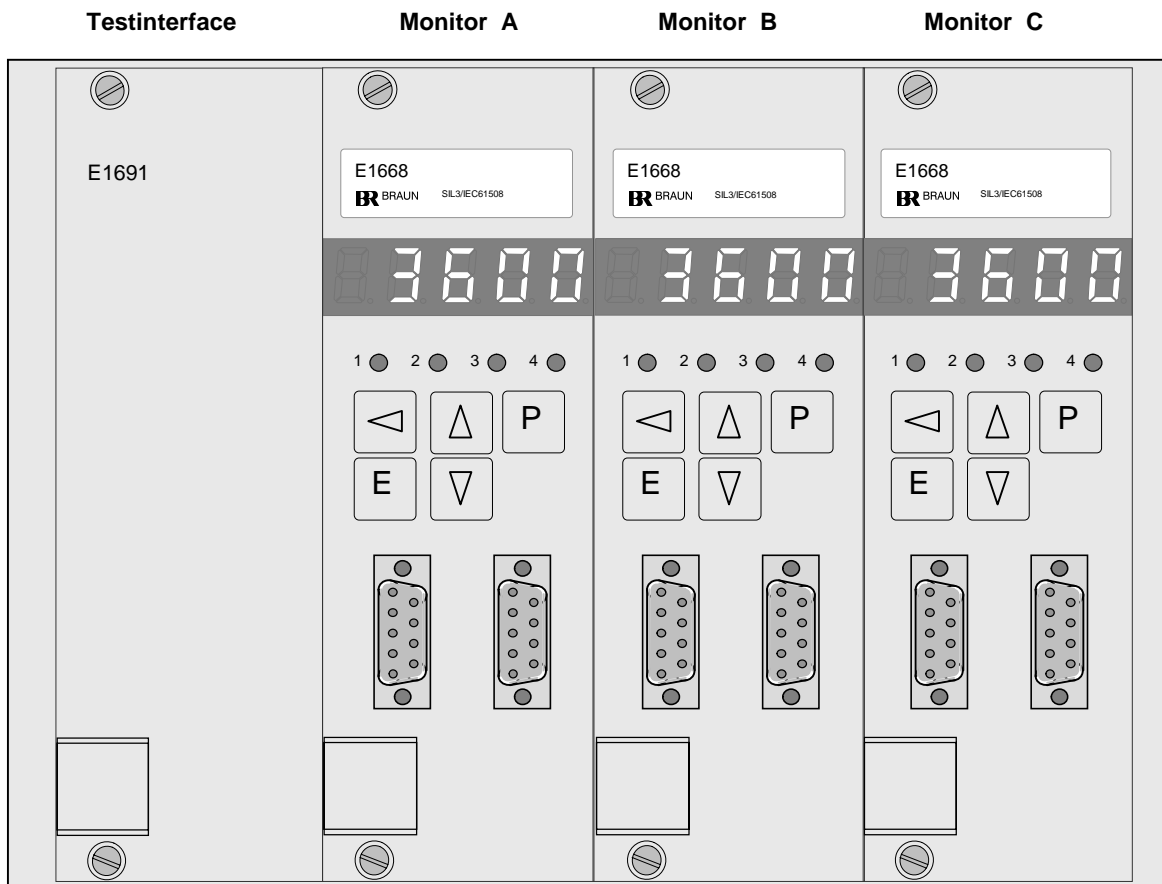

Figure 1: E16x352 System Front View

Contents	Page
1. General Informations	4
1.1. List of Figures.....	4
1.2. List of Abbreviations.....	5
1.3. System Applications and Explanation	7
1.4. Key Features of System E16x352.....	7
1.5. Ordering Key for Systems E16x352.abc.....	8
1.6. Certifications	9
1.6.1. Certification IEC61508; SIL3	9
1.6.2. Certification DIN EN ISO 13849-1:2008; Cat.3 PLe	9
1.6.3. TÜV-Certificate	10
1.7. Safety Data.....	11
1.7.1. Safety Data IEC61508; SIL3	11
1.7.2. Safety Data DIN EN ISO 13849-1:2008; Cat.3 PLe	11
1.8. External Tests	11
1.8.1. External tests during normal operation by PLC or operator	11
1.8.2. Test of 2oo3 solenoid valve block	11
2. System Structure and I/Os.....	12
2.1. System Structure.....	12
2.1.1. Speed Sensors.....	12
2.1.2. System Components	12
2.1.3. System Design	12
2.1.4. System Structure Diagrams	13
2.1.5. System Wiring Diagrams.....	15
2.1.6. Connection of Sensors to the Speed Signal Inputs.....	17
2.1.7. Position of Terminal Blocks with Version E16E352.....	18
2.1.8. Position of Terminal Blocks with version E16A352	19
2.2. Inputs of the System	20
2.2.1. Speed Signal Inputs	20
2.2.2. Direction Signal Inputs (F/R : Forward/Reverse).....	20
2.2.3. Input Reset of Alarms.....	20
2.2.4. This chapter is left blank intentionally	20
2.2.5. This chapter is left blank intentionally	20
2.2.6. Inputs Test I, Test II, Test III.....	21
2.2.7. Inputs Starter (Override of SP2).....	21
2.2.8. Inputs SP1B valid	21
2.2.9. This chapter is left blank intentionally	21
2.2.10. Inputs for Voter 1.....	21
2.2.11. Inputs for Voters 2 ... 6	21
2.3. Outputs of the System.....	22
2.3.1. Output System Warning Alarm.....	22
2.3.2. Speed Signal Repeater Outputs.....	22
2.3.3. Outputs Monitor Warning Alarm	22
2.3.4. Outputs Speed Alarm SP3	22
2.3.5. Analog Outputs for measured speed (Option).....	23
2.3.6. Outputs Direction Detection	23
2.3.7. Speed Trip Logic Output (2oo3 voted)	23
2.3.8. Outputs Trip-Line IV, V, VI	23
2.3.9. Outputs Trip-Line I, II, III.....	23
2.3.10. Logic Outputs LO1 through LO6 (voted 2oo3)	23
2.3.11. Trip Status of Monitors	24
2.4. Power Supply	25
2.5. Data Interface.....	25
2.5.1. Profibus Interface for Status and Diagnostics of the System	25
2.5.2. RS232 Interface with Interface Software IS-RS232-E16 (for OEM only).....	25
2.5.3. RS232 Interface with Interface Software IS-RS232-E16-L2 (for End User)	25
3. Technical Specifications	26
3.1. Technical Data of Inputs	26

3.1.1.	Technical Data of Speed Signal Inputs	26
3.1.1.1.	Hall Sensor Inputs	26
3.1.1.2.	Eddy Current Sensor Inputs resp. MPU Inputs	26
3.1.2.	Technical Data of Direction Inputs	26
3.1.3.	Technical Data of Binary Inputs (excluding Voter 1)	26
3.1.4.	Technical Data of Binary Inputs of Voter 1	26
3.2.	Technical Data of Outputs.....	27
3.2.1.	Technical Data of Sensor Signal Repeater Outputs.....	27
3.2.2.	Technical Data of Analog Outputs.....	27
3.2.3.	Technical Data of Opto-Relay Outputs.....	27
3.2.4.	Technical Data of Logic Outputs	27
3.2.5.	Technical Data of Trip-Lines IV, V, VI	28
3.2.6.	Technical Data of Trip-Lines I, II, III	28
3.3.	Technical Data of Power Supply	29
3.4.	Installation Conditions	29
3.5.	Protection Grade	29
3.6.	Connectors.....	29
3.7.	Conformity to Standards.....	29
3.8.	Dimensions of system E16A352	30
3.9.	Dimensions of system E16E352	31
3.10.	Dimensions and Features of E16G352 Enclosure	32
3.11.	Weight of E16x352.....	32
4.	Safety Notes for Installation and Operation.....	33
4.1.	Safety Notes for Installation	33
4.1.1.	General Instructions	33
4.1.2.	EMI	33
4.2.	Safety Notes for Operation.....	33
4.2.1.	Safety Notes for Commissioning.....	33
5.	Description of Monitor E1668.....	34
5.1.	Display and Frontside Operational Elements.....	34
5.1.1.	Front View of Monitor E1668.....	34
5.1.2.	Status-LEDs	34
5.1.3.	Display during Test Procedures	34
5.1.4.	Values accessible during normal operation	35
5.1.5.	Display of Firmware Release State and CRC-Parameter-Checksum of Monitor E1668	35
5.1.6.	Special Display Mode 1	36
5.1.7.	Special Display Mode 2.....	36
5.1.8.	Frontside Reset of Alarms and Event Codes	36
5.1.9.	Data Interface.....	36
5.2.	Functions of Monitor E1668	37
5.2.1.	Speed Measurement.....	37
5.2.2.	Functions for Overspeed Protection.....	37
5.2.3.	Functions for External Trip by Voters	37
5.2.4.	Selftest of Monitor	37
6.	Description of Testinterface E1691	38
7.	Programming of the Monitors	39
7.1.	Programming of the Monitors via Front Keyboard.....	39
7.2.	Programming of the Modules via RS232-Interface	40
7.3.	Default Values.....	40
8.	Parameters of Monitor E1668.....	41
8.1.	Summary of parameters and their default values.....	41
8.2.	Description of Parameters and their Settings of Monitor E1668	45
9.	This chapter is left blank intentionally	73
10.	Event codes and Troubleshooting	73
10.1.	Event Codes on display of E1668	73
10.2.	Troubleshooting if display of Monitor reads E.0.4.x.x.....	74
11.	Revision notes.....	75

1. General Informations

1.1. List of Figures

Figure 1:	E16x352 System Front View	1
Figure 2:	E16x352 System Structure Diagram 1 of 2	13
Figure 3:	E16x352 System Structure Diagram 2 of 2	14
Figure 4:	E16x352 System Wiring Diagram 1 of 3	15
Figure 5:	E16x352 System Wiring Diagram 2 of 3	16
Figure 6:	E16x352 System Wiring Diagram 3 of 3	17
Figure 7:	Position of terminal blocks with version E16E352	18
Figure 8:	Position of terminal blocks with version E16A352	19
Figure 9:	Dimensions of System E16A352	30
Figure 10:	Dimensions of System E16E352	31
Figure 11:	Dimensions of E16G352 Enclosure	32
Figure 12:	Front view of Monitor E1668	34
Figure 13:	SP1 as a variable of the acceleration	53

1.2. List of Abbreviations

Abbreviation	Meaning
altern.	alternative
API	Technical standards of the "American Petroleum Institute"
A5S	BRAUN GmbH Sensor series
AWG/kcmil	Code number according to the "American Wire Gauge" System
approx.	approximately
CCF	Common Cause Failure
CPU	Central Processing Unit
DCavg	Diagnostic Coverage average
DIN	Deutsches Institut für Normung (German Institute for Standardization)
dN/dt	Change of speed per time unit (Acceleration)
EEPROM	Electrically Erasable Programmable Read-Only Memory
EMV	Electro magnetic compatibility
EN	European Norm
F/R	Forward/Reverse (Forward/Backward)
HE	Height units
HFT	Hardware Failure Tolerance
IEC	International Electrotechnical Commission
incl.	inclusive
IPxx	Ingress Protection Number xx according to DIN EN 60529
ISO	International Organization for Standardization
LED	Light Emitting Diode
LOx	Logic Output x
max.	maximum
min.	minimum
MPU	Magnetic Pick Up
MTTFd	Mean Time To Failure dangerous
n	Short term for Speed
NEMAx	National Electrical Manufacturers Association Number x
PFDavg	Probability of Failure on Demand average
PELV	Protective Extra Low Voltage
RAM	Random Access Memory
RPM	Revolutions Per Minute
sec	second
SELV	Safety Extra Low Voltage
SFF	Safe Failure Fraction
SILx	Safety Integrity Level x
SPx	SetPoint x
SPVx	SetPoint Voter x
SP1var	SetPoint 1 variable
TE	Width unit
TMR	Triple Modular Redundant
Tproof	Proof Test Interval
UL/cUL	Acc. US Underwriter Laboratories resp. Canadian Underwriter Laboratories standards
Vdc	Volt direct current
Vpp	Volt peak-to-peak
resp.	respective
	to be continued on next page

Abbreviation	Meaning
1oo2	1 out of 2 voting logic
1oo3	1 out of 3 voting logic
2oo2	2 out of 2 voting logic
2oo3	2 out of 3 voting logic

1.3. System Applications and Explanation

Protection of rotating machinery such as turbines, expanders, compressors and motors with safety requirements SIL3/IEC61508 resp. DIN EN ISO 13849:2008 Cat.3 PLe and/or API 670 versus Overspeed and other Critical Conditions.

The E16x352 system incorporates one Testinterface type E1691 and three Monitors (channels) A, B and C of type E1668 for the evaluation of speed signals and external trip signals. The logic blocks for the evaluation of the external trip signals are named "Voter".

The logic results of the three channels are connected internally to form three 2oo3 trip circuits I, II and III which are named "Trip-Lines".

The Trip-Lines can be connected to a 1oo2 or 2oo3 solenoid valve block.

A released trip status can be latched, this function is named "Trip-Lock".

Trip is released by shut down of the Trip Circuits (Trip-Lines) to the solenoid valve block if:

- 2oo3 monitors detect Overspeed condition
- 2oo3 sensor signals are detected as faulty by monitors
- 2oo3 monitors detect External Trip-Condition by their voters (1oo2, 2oo2, 2oo3 or 3oo3 logic selectable)

1.4. Key Features of System E16x352

Trip Release Function is SIL3/IEC61508 and DIN EN ISO 13849:2008 Cat.3 PLe compliant as stand alone unit (without external testing by DCS or by operator).

Total Response Time to Trip Condition : < 15 milliseconds

Maximum Safety at Maximum Availability by :

- TMR (Triple Modular Redundancy) with three monitors E1668.
- Triple speed measurement and evaluation by each monitor.
- Variable overspeed setpoint depending on acceleration.
- Monitoring versus Lowspeed as protection versus incorrect mounting or malfunction of speed sensors.
- Permanent monitoring of speed sensors.
- Evaluation of external Trip-Condition signals by voters in each monitor. Response to signals selectable for each voter individually (logic function, low/high: trip, response time).
- Each Trip Line (trip circuit) in 2oo3 technique.
- Trip Lines I, II, III, IV, V, VI are formed by safety relays with force guided contact sets.
- Trip-Line-Monitoring with Trip-Lock Function (selectable)
- The outputs of the Trip Lines I, II and III are permanently monitored. If the Trip-Lock Function is engaged, a trip condition is detected and locked if 2oo3 trip lines are in trip condition.
- By the (selectable) Trip-Lock Function a released trip is latched

Additional features of the E16x352-System:

- Remote test of solenoid valve block by test signals from DCS possible
- Display in each module for measured values and diagnostics
- Alarm outputs via opto-relays to DCS
- Free extra alarm from each monitor
- Up to 6 speed setpoints with 2oo3 logic outputs (if voters are not required)
- Sensor signal repeater outputs, free floating and push/pull
- Optional Analog Output (to represent the speed) 0/4..20 mamps for each monitor
- Direction alarm (only with sensors type A5S with direction output)
- Parameters may be set by front keys (protected by code-digit) or by RS232-Interface (password protected)

1.5. Ordering Key for Systems E16x352.abc

E16x352.abc

- c = 1** : Speed Signal Inputs and power supply for A5S sensors
- c = 2** : Speed Signal Inputs and power supply for Eddy Current Sensors
- c = 3** : Speed Signal Inputs for MPU (magnetic pick up)

- b = 1** : 1 Voter in each Monitor for external trip release condition
- b = 2** : 6 Voters in each Monitor for external trip release conditions

- a = 0** : without Analog Output (to represent the speed)
- a = 1** : 1 Analog Output in each Monitor A, B, C
- a = 2** : 1 Analog Output rated SIL3 in each Monitor A, B, C

- x = A** : Surface Mount Version
- x = E** : 19-Inch Rack File
- x = G** : Nema 4 Version with front window (surface mount)

Example:

- E16A352.021 : Surface Mount Version, without Analog Output, with 6 Voters, Speed Signal Inputs for A5S sensors
- E16A352.112 : Surface Mount Version, with Analog Output, with 1 Voter, Speed Signal Inputs for eddy current sensors
- E16A352.013 : Surface Mount Version, with 1 Voter, Speed Signal Inputs for MPU

1.6. Certifications

1.6.1. Certification IEC61508; SIL3

The E16x3xx system is certified by TÜV-Nord to be compliant with IEC61508; SIL3 as a stand alone TMR Trip-System for Overspeed Protection and Voters for external Trip Release Conditions, such as emergency stop, boiler protection etc.

1.6.2. Certification DIN EN ISO 13849-1:2008; Cat.3 PLe

The E16x3xx system is certified by TÜV-Nord to be compliant with DIN EN ISO 13849:2008; Cat.3 PLe as a stand alone TMR Trip-System for Overspeed Protection and Voters for external Trip Release Conditions, such as emergency stop, boiler protection etc.



Certificate

Nr. SEBS-A.144312/12, V1.1

TÜV NORD Systems GmbH & Co. KG hereby certifies to

Braun GmbH
Esslinger Straße 26
71334 Waiblingen-Hegnach

that the “Safety-Related Protection System”

Types E16x3xx.abc

meets the requirements listed in the below mentioned standards

- IEC 61508:2010 (capable up to SIL 3)
- DIN EN ISO 13849-1:2008 (capable up to PL e; Cat. 3)
- IEC 62061:2005 (capable for applications up to SIL_{CL} 3)

Base of certification is the report SEBS-A.144312/12TB1 and the tracking list in the valid version. This certificate entitles the holder to use the pictured safety approved mark.

Valid until: 03-04-2019
File reference: 8109668814

Hamburg, 03-04-2014

Bianca Pfuff

SEECERT Software & Electronics Certification Body
TÜV NORD Systems GmbH & Co. KG
Große Bahnstraße 31, 22525 Hamburg, Germany

Please note our Test and Certification-Regulation on the back



1.7. Safety Data

1.7.1. Safety Data IEC61508; SIL3

System Type B; HFT = 1; Architecture 2oo3, Service Time 20 years
PFD_{avg} = $7,71 \cdot 10^{-5}$ at **T1** (Proof Check Interval) = 20 years

1.7.2. Safety Data DIN EN ISO 13849-1:2008; Cat.3 PLe

System Type B; HFT = 1; Architecture 2oo3, Service Time 20 years
MTTF_d = not yet calculated
DC_{avg} = not yet calculated

1.8. External Tests

1.8.1. External tests during normal operation by PLC or operator

The trip release ability of a 2oo3 solenoid valve block can be verified by external tests as described in 1.6.1.

Test interval for test 1.6.1 according recommendations of the 2oo3 solenoid valve block supplier.

1.8.2. Test of 2oo3 solenoid valve block

Test can only be performed if the Monitors are not in trip status.

The test is performed for each trip-line separately by control signals Test of Trip-Line I, II, III. The response of the 2oo3 solenoid valve block must be checked by the PLC resp. the operator.

Note:

Test of two or three trip-lines at the same time will release trip of the machine.

2. System Structure and I/Os

2.1. System Structure

The structure of the system is shown in chapter **2.1.4.** (figures 2 and 3).

The wiring of the system is shown in chapter **2.1.5.** (figures 4, 5 and 6).

The indexes "see 2.x.x" in these figures refer to the corresponding chapters 2.x.x. which describe the according functions.

2.1.1. Speed Sensors

With versions E16x352.xx1:

Three A5S Differential-Hall-effect sensors, with integrated signal amplifier are placed at the machine shaft.

The Differential Hall-effect sensors A5S are not susceptible to uniform external magnetic fields. Air gap variations between machine and sensor do not create false signals.

With versions E16x352.xx2:

Three Speed signals from Eddy Current Sensors are evaluated.

With versions E16x352.xx3:

Three Speed signals from MPU Sensors are evaluated.

2.1.2. System Components

The system comprises three Monitors E1668 for speed monitoring and for monitoring of the external trip conditions and one Testinterface E1691 to process the trip-line test signals and the trip status signals between Monitors and the PLC.

The Monitors and the Testinterface are connected via a backplane. The backplane does not hold any active components.

2.1.3. System Design

The system is available as

- 19-Inch Rack File, 3HE 84TE (E16E352) or
- for surface mounting (E16A352) or
- as NEMA4 version (E16G352).

2.1.4. System Structure Diagrams

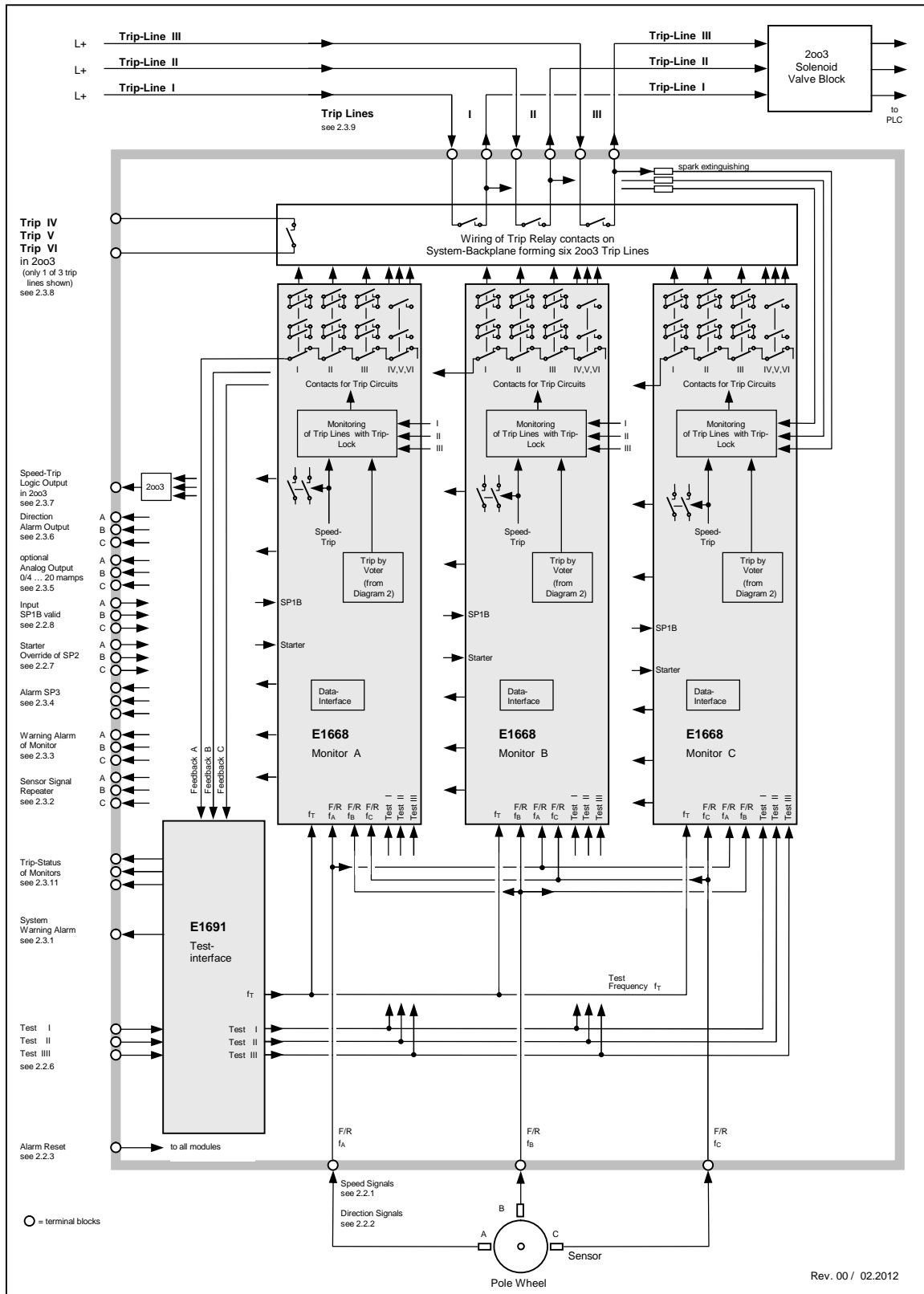

Figure 2: E16x352 System Structure Diagram 1 of 2

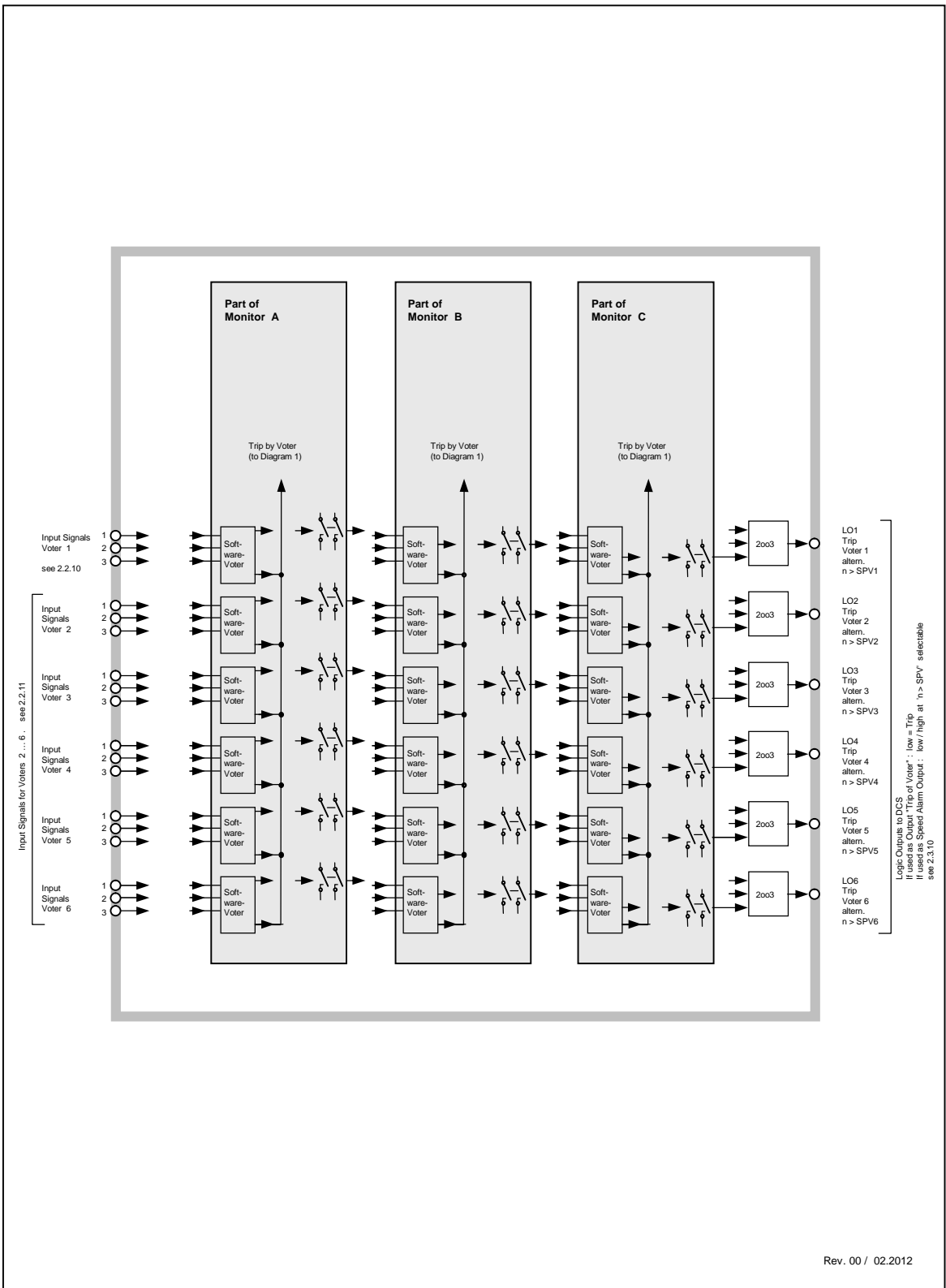

Figure 3: E16x352 System Structure Diagram 2 of 2

2.1.5. System Wiring Diagrams

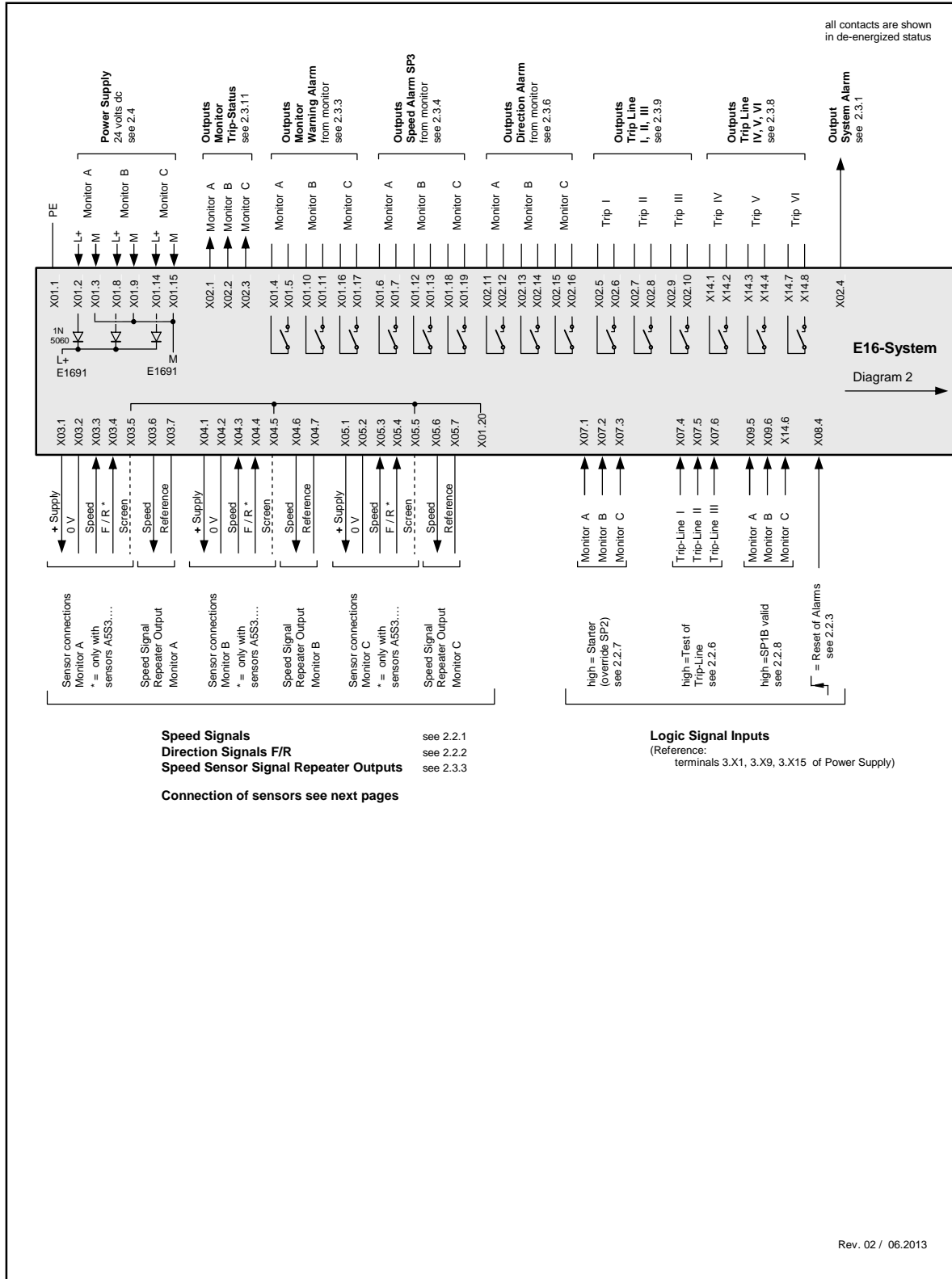

Figure 4: E16x352 System Wiring Diagram 1 of 3

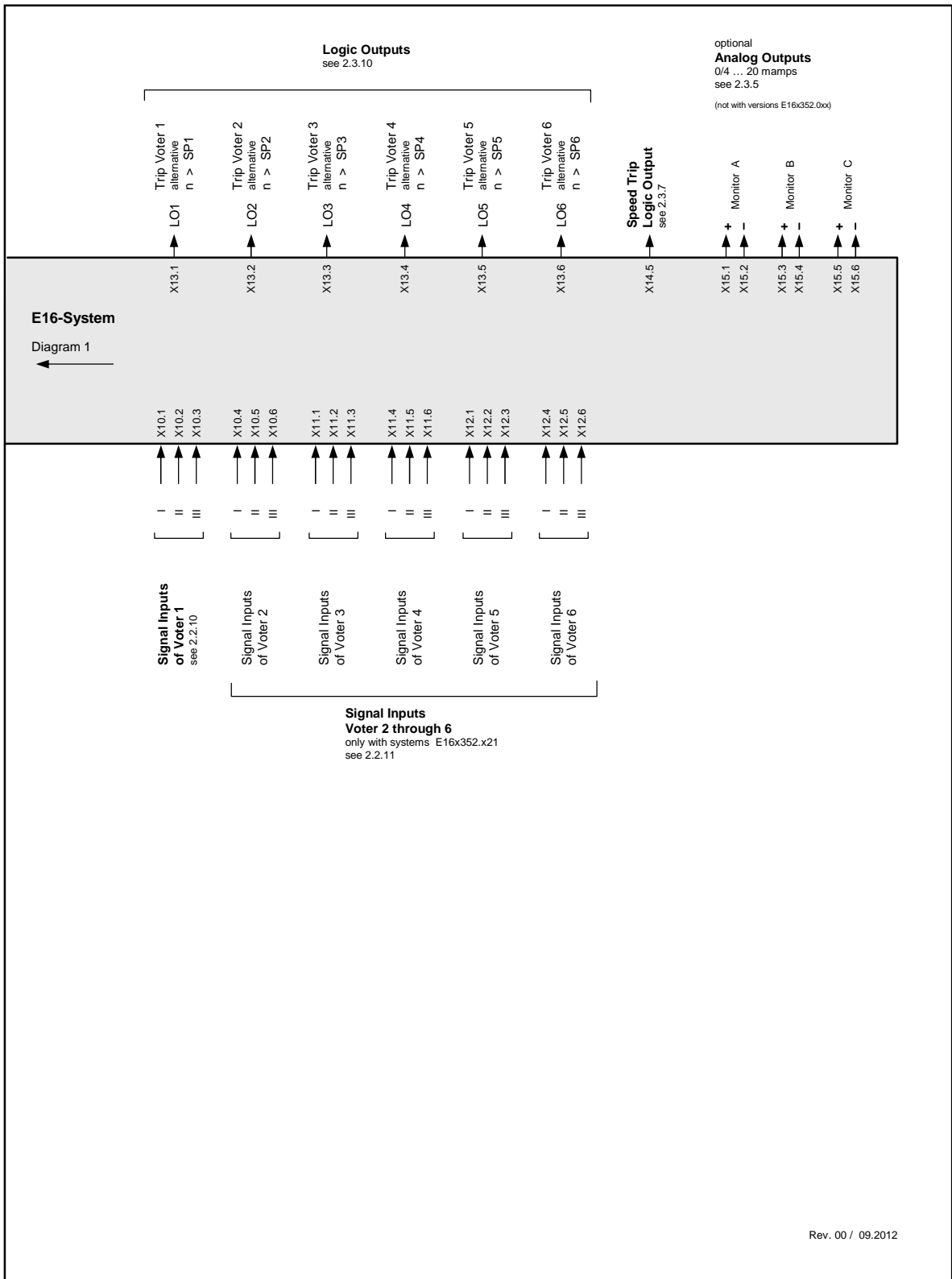
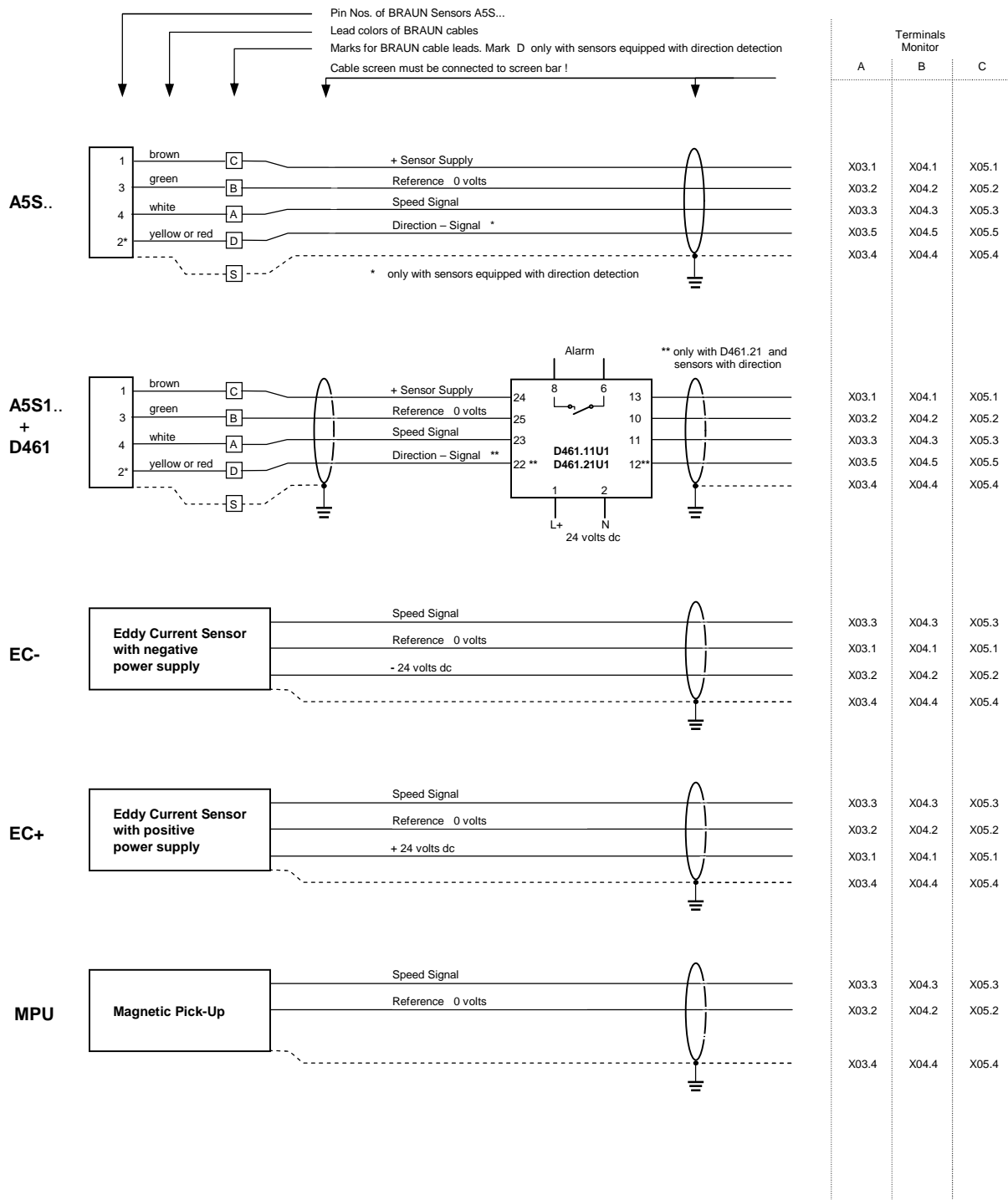

Figure 5: E16x352 System Wiring Diagram 2 of 3

2.1.6. Connection of Sensors to the Speed Signal Inputs



Rev. 00 / 09.2012

Figure 6: E16x352 System Wiring Diagram 3 of 3

2.1.7. Position of Terminal Blocks with Version E16E352

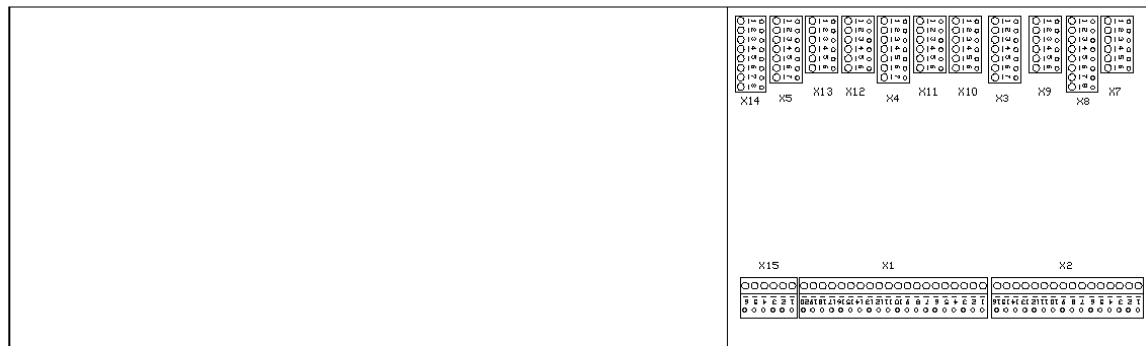

Figure 7: Position of terminal blocks with version E16E352

2.1.8. Position of Terminal Blocks with version E16A352

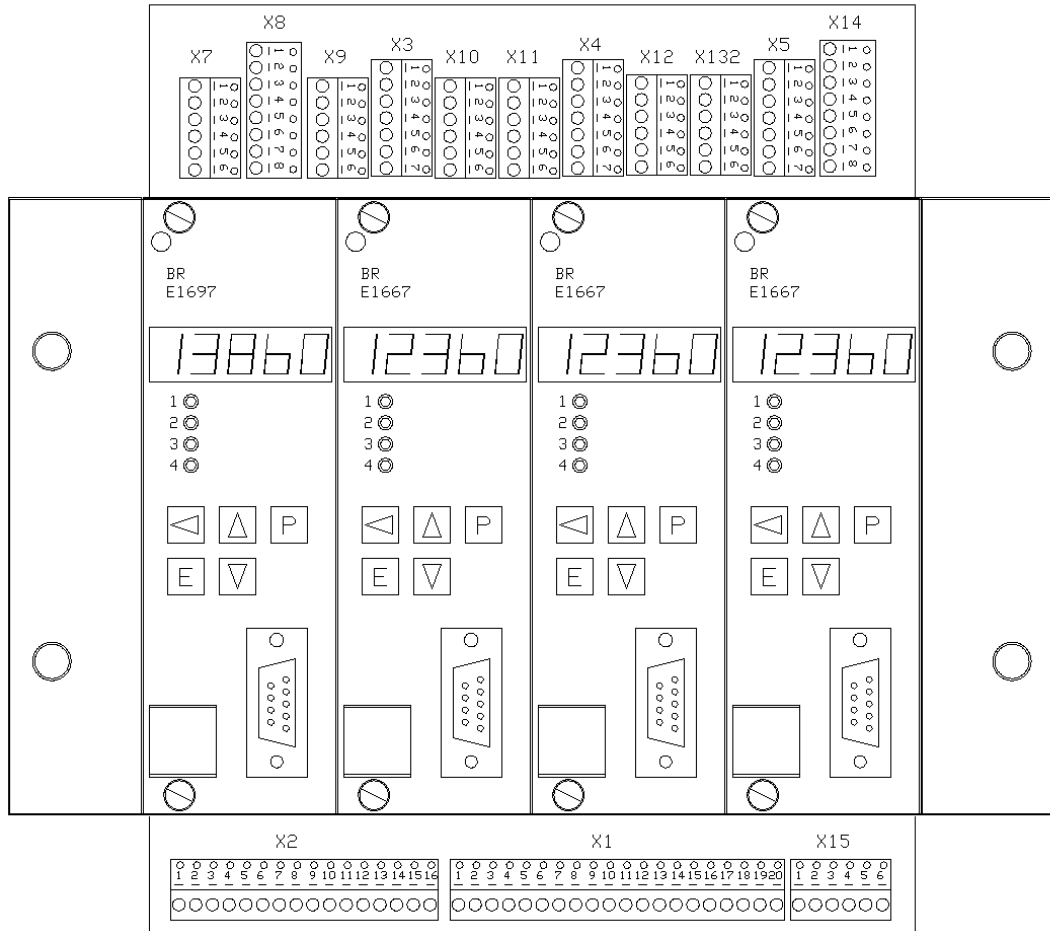

Figure 8: Position of terminal blocks with version E16A352 (shown is version E16A346)

2.2. Inputs of the System

2.2.1. Speed Signal Inputs

The speed signals are internally wired to all three Monitors in parallel.

With versions E16x352.xx1:

The speed signal inputs match the values of sensors A5S...

The speed signal inputs are rated SIL3/IEC61508 if sensors of type A5S. (also via barriers D461) are connected. For other sensors this is only valid, if the sensor supplier guarantees, that the sensors will not give erratic speed signals due to a common cause failure. The instructions of the sensor supplier must be observed.

Technical Data of inputs see 3.1.1.1.

With versions E16x352.xx2:

The signal inputs match the values of eddy current sensors.

The speed signal inputs are rated SIL3/IEC61508, if the sensor supplier guarantees, that the sensors will not give erratic speed signals due to a common cause failure. The instructions of the sensor supplier must be observed.

Technical Data of inputs see 3.1.1.2.

With versions E16x352.xx3:

The signal inputs match the values of MPUs.

The speed signal inputs are rated SIL3/IEC61508, if the sensor supplier guarantees, that the sensors will not give erratic speed signals due to a common cause failure. The instructions of the sensor supplier must be observed.

Technical Data of inputs see 3.1.1.2.

2.2.2. Direction Signal Inputs (F/R : Forward/Reverse)

The direction signal inputs match the values of the sensors A5S with direction signal.

The direction signals are internally wired to all three monitors in parallel.

The direction signal inputs are rated SIL3/IEC61508 (valid only for sensors A5S3..).

Technical Data of inputs see 3.1.2.

2.2.3. Input Reset of Alarms

The Reset signal is internally connected to all modules in parallel. It resets a no longer prevailing, but latched alarm or trip condition.

A signal transition from low to high will reset a latched alarm.

Minimum Time of Reset Signal: > 1 second to ensure correct reset of all modules.

The input "Reset of Alarms" is rated SIL3/IEC61508 provided that the signal source is rated SIL3/IEC61508.

Technical Data of input see 3.1.3.

2.2.4. This chapter is left blank intentionally

2.2.5. This chapter is left blank intentionally

2.2.6. Inputs Test I, Test II, Test III

If the input is high, the corresponding Trip-Line will switch to trip condition.

The inputs are not inhibited versus each other.

The inputs "Test I, II, III" are rated SIL3/IEC61508 provided that the signal source is rated SIL3/IEC61508.

Technical Data of inputs see 3.1.3.

2.2.7. Inputs Starter (Override of SP2)

Each monitor has one input for the starter condition. As long as the input is high, the starter condition is true.

During starter condition the monitoring versus Lowspeed (SP2) is disabled.

The inputs "Starter" are rated SIL3/IEC61508 provided that the signal source is rated SIL3/IEC61508.

Technical Data of inputs see 3.1.3.

2.2.8. Inputs SP1B valid

Each monitor has one input to select SP1B as trip setpoint.

As long as the input is high, setpoint value SP1B (see step P03.03 of E1668) is true.

With open input (low), setpoint value SP1A (see P03.00 of E1668) is true. The inputs "SP!B valid" are rated SIL3/IEC61508 provided that the signal source is rated SIL3/IEC61508.

Technical Data of inputs see 3.1.3.

2.2.9. This chapter is left blank intentionally

2.2.10. Inputs for Voter 1

The input signals for Voter 1 are internally connected to all monitors in parallel.

The input load of Voter 1 meets the requirements for the redundant outputs of a failsafe PLC (load > 45 ma per input).

The signal truth level (high or low as trip condition), the voting principle (1oo2, 2oo2, 2oo3, 3oo3) and the response time is selectable. Configuration of the voter is done in steps P10.xx of E1668.

The inputs "Voter 1" are rated SIL3/IEC61508 provided that the signal source is rated SIL3/IEC61508.

Technical Data of inputs for Voter 1 see 3.1.4.

2.2.11. Inputs for Voters 2 ... 6

The input signals for Voters 2 ... 6 are internally connected to all monitors in parallel.

The signal truth level (high or low : trip condition), the voting principle (1oo2, 2oo2, 2oo3, 3oo3) and the response time is selectable for each voter individually. Configuration of voters is done in steps P11.xx to P15.xx of E1668.

Technical Data of inputs for Voter 2 ... 6 see 3.1.3.

The inputs "Voter 2...6" are rated SIL3/IEC61508 provided that the signal source is rated SIL3/IEC61508.

Technical Data of inputs for Voter 2 ... 6 see 3.1.3.

Note:

Systems E16x352.x1x do not have inputs for Voters 2 ... 6 .

2.3. Outputs of the System

2.3.1. Output System Warning Alarm

Output System Warning Alarm is released if

- minimum one Monitor signalizes a nonconformity at its voter inputs
- minimum one Monitor is faulty
- minimum one Monitor is in trip status

Note:

The System Warning Alarm has a delay of approx. 10 seconds versus the releasing monitor.

Technical Data of output see 3.2.4

The output "System Warning Alarm" is rated SIL2/IEC61508.

Technical Data of output see 3.2.4.

2.3.2. Speed Signal Repeater Outputs

Each Monitor repeats the speed signal of its main sensor (Monitor A repeats sensor signal A) to the periphery.

The Speed Signal Repeater Outputs are rated SIL2/IEC61508.

Technical Data of outputs see 3.2.1.

2.3.3. Outputs Monitor Warning Alarm

The Monitor Warning Alarm (for each Monitor individually) is released if at least one of the following conditions is true:

- Monitor releases trip (due to overspeed resp. voter), if selected
Selection in step P02.11 of E1668
- Deviation of its own sensors versus both sensors of neighbor Monitors, if monitored
Selection in steps P02.07 through P02.09 of E1668
- Measured speed lower than SP2 (after starter condition), if monitored
Selection in step P02.06 of E1668
- Sensor Circuit Fault, if monitored
Selections in steps P02.04 and P02.05 of E1668
- If starter condition is still true and speed exceeds 50% of nominal speed (as set in step P01.03), if selected in step P02.06

Note:

The Monitor Warning Alarm is not released, if the Monitor detects a nonconformity at its voter inputs. This status is forwarded to the Testinterface E1691 which then releases the System Warning Alarm.

The outputs "Monitor Warning Alarm" are rated SIL2/IEC61508.

Technical Data of outputs see 3.2.3.

2.3.4. Outputs Speed Alarm SP3

Each Monitor has a free adjustable speed alarm output SP3.

Configuration of SP3 in steps P05.xx of E1668.

The outputs "Speed Alarm SP3" are rated SIL2/IEC61508.

Technical Data of outputs see 3.2.3.

2.3.5. Analog Outputs for measured speed (Option)

The (optional) analog outputs have a range of 0/4 .. 20 mamps.
Configuration of the analog output in steps P08.xx of E1668.
The analog outputs of versions E16x352.1xx are rated SIL2/IEC61508.
The analog outputs of Monitors E16x352.2xx are rated SIL3/IEC61508.
Technical Data of outputs see 3.2.2.

2.3.6. Outputs Direction Detection

If operated with sensors A5S with incorporated direction signal output, the sense of direction is signalized.
Each Monitor votes the direction input signals 2oo3. Each Monitor has a direction alarm output.
The outputs "Direction Detection" are rated SIL2/IEC61508.
Technical Data of outputs see 3.2.3.

2.3.7. Speed Trip Logic Output (2oo3 voted)

Speed Trip Logic Output is released, if minimum 2 of the 3 monitors detect overspeed condition. If overspeed status is latched, the alarm will persist until reset.
Output high: no speed trip
Output low: speed trip
The Speed Trip Logic Output is rated SIL2/IEC61508.
Technical Data of output see 3.2.4.

2.3.8. Outputs Trip-Line IV, V, VI

The Trip-Lines IV, V, VI are 2oo3-circuits formed by two contacts each of safety trip relays of Monitors A,B,C.
Trip is released if minimum two Monitors E1668 are in trip status.
Trip-Lines IV, V, VI are intended to signalize the trip via three signals to a DCS or PLC.
Note:
If only one signal is connected to the DCS or PLC and this signal releases trip, at least two outputs must be connected in parallel to avoid an inadvertent trip due to contact failure of a trip relay during trip relay test.
Trip-Lines IV, V, VI are rated SIL3/IEC61508.
Technical Data of output see 3.2.5.

2.3.9. Outputs Trip-Line I, II, III

The Trip-Lines I, II, III are 2oo3-circuits formed by four contacts each (two each connected in parallel for higher availability during trip relay test) of safety trip relays I resp. II, resp. III of Monitors A,B,C.
Trip is released if minimum two monitors E1668 are in trip status.
Trip-Lines I, II, III are intended to supply shutdown solenoid valves.
Trip-Lines I, II, III are rated SIL3/IEC61508.
Technical Data of output see 3.2.6.

2.3.10. Logic Outputs LO1 through LO6 (voted 2oo3)

The logic outputs LO may be assigned to signalize a voter trip or to a speed setpoint.
If assigned to Voter Trip: Output high: no trip of Voter
Output low: trip of Voter
If assigned to speed alarm: Output high/low if $n > SP$ is selectable.
The Logic Outputs LO1 through LO6 are rated SIL2/IEC61508.
Technical Data of outputs see 3.2.4.

2.3.11. Trip Status of Monitors

Each Monitor reflects its trip status via the Testinterface as a logic signal to the periphery.

Output high: no trip

Output low: trip

Note:

The outputs have a delay of approx. 10 seconds versus the trip of the monitor.

The Outputs "Trip Status of Monitor" are rated SIL2/IEC61508.

Technical Data of output see 3.2.4

2.4. Power Supply

Each Monitor must be supplied with 24 volts dc (18..40 volts) from a power supply with protective separation, conforming to IEC 61131-2 requirements.

The Test Interface E1691 is fed by an internal power rail.

Technical Data see 3.3.

2.5. Data Interface

Each of the Monitors E1668 carry a 9pole Sub-D-connector (female). Implemented on this connector are a Profibus-Interface (with standard-pinning) and a RS232-Interface (non standard pinning).

2.5.1. Profibus Interface for Status and Diagnostics of the System

The Profibus Interface reflects the standard Profibus DP and serves for the upload of status and diagnostics of the system to a PLC or DCS.

2.5.2. RS232 Interface with Interface Software IS-RS232-E16 (for OEM only)

The RS232 Interface in conjunction with the Interface-Software IS-RS232-E16 (available for OEM only) serves

- to edit parameters
- to configure parameter settings as *.brp files
- to upload parameter settings from Monitors as *.brv files
- to download parameter settings from *.brp or *.brv files to the Monitors

2.5.3. RS232 Interface with Interface Software IS-RS232-E16-L2 (for End User)

The RS232 Interface in conjunction with the Interface-Software IS-RS232-E16-L2 (available for End Users) serves

- to upload parameter settings from Monitors as *.brv files
- to download parameter settings from *.brv files to spare part Monitors

Note: Parameter settings cannot be changed.

3. Technical Specifications

3.1. Technical Data of Inputs

3.1.1. Technical Data of Speed Signal Inputs

3.1.1.1. Hall Sensor Inputs

Maximum Input Frequency : 50 kHz

Maximum Signal Voltage : 30 volts

Input low at : < 3 volts

Input high at : > 7 volts

Impedance : approx. 5 kohms

Sensor Supply : approx. 13 volts, maximum 80 mamps

The sensor inputs have the same common, but are free floating versus other potentials.

They are powered by an internal power supply.

3.1.1.2. Eddy Current Sensor Inputs resp. MPU Inputs

Maximum Input Frequency : 30 kHz

Maximum Signal Voltage : 30 volts

Trigger Hysteresis : 0.07 to 2.5 Vpp

Impedance : approx. 47 kohms

Sensor Supply: (only with versions E16x352.xx2): approx. 24 volts, maximum 120 mamps

Inputs are free floating.

The sensor inputs have the same common, but are free floating versus other potentials.

They are powered by an internal power supply.

3.1.2. Technical Data of Direction Inputs

Maximum Signal Voltage : 30 volts

Input low at : < 3 volts

Input high at : > 7 volts

Impedance : approx. 22 kohms

Same Reference as Speed Signal Inputs.

3.1.3. Technical Data of Binary Inputs (excluding Voter 1)

Input high : 18..48 volts (nominal current at 24 volts: 6 mamps)

Input low : < 3 volts or open input

Reference : negative pole of power supply

3.1.4. Technical Data of Binary Inputs of Voter 1

Input high : 18..30 volts (nominal current at 24 volts: 45 mamps)

Input low : < 3 volts or open input

Reference : negative pole of power supply

3.2. Technical Data of Outputs

3.2.1. Technical Data of Sensor Signal Repeater Outputs

High-Level : > 20 volts with max. load, (maximum 26 volts without load)

Low-Level : < 2 volts, with max. load

Maximum load: 1 kohms

Outputs are short-circuit proof and free floating (also versus each other).

Outputs are supplied by free floating power sources within the monitors.

3.2.2. Technical Data of Analog Outputs

Range : 0/4...20 mamps

Resolution : 12 Bit

Maximum load : 500 ohms

Linearity error : < 0.1%

Temperature stability : $\pm 0,02$ %/°C within a range of 0...60°C.

Outputs are short-circuit proof and free floating (also versus each other).

3.2.3. Technical Data of Opto-Relay Outputs

Maximum rating : 50 volts dc / 50 mamps.

Outputs are passive, short-circuit proof and free floating (also versus each other). They must be supplied externally.

Note:

In case of short circuit the output is latched to tristate until power supply of the monitor has been switched off and on.

3.2.4. Technical Data of Logic Outputs

The outputs are fed from the system power supply.

Reference : L- (negative pole of power supply).

High-Level : Power supply L+ minus 2 volts

Low-Level : < 3 volts

Maximum output current : 50 milliamps

Outputs are short-circuit proof.

Note:

In case of short circuit the output is latched to tri state until power supply of the monitor has been switched off and on.

3.2.5. Technical Data of Trip-Lines IV, V, VI

Maximum rating : 50 volts dc / 300 mamps.

Outputs are passive, short-circuit proof and free floating. They must be supplied externally.

3.2.6. Technical Data of Trip-Lines I, II, III

Maximum rating : 50 volts dc / 3 amps / 75 watts

Maximum rating for DC13-applications : 24 volts / 3 amps

Outputs are not short-circuit proof (permanent currents exceeding 8 amps will destroy outputs).

Impedance : 10 kohms versus L- (negative pole of power supply)

For inductive type loads, external spark extinguishing means must be provided.

Total response time (trip relays de-energize to trip) from trip event until trip circuits are in trip condition : < 15 milliseconds.

3.3. Technical Data of Power Supply

3x 24 volts dc / 0.5 amps (18...40 volts) from a power supply with protective separation, conforming to IEC 61131-2 requirements.
Maximum consumption of system : 20 watts

3.4. Installation Conditions

Ambient temperature in operation : 0°C..+55°C
Ambient temperature in storage: -20°C..+85°C
Relative humidity < 80%
To be installed in dry cabinets in air-conditioned rooms

3.5. Protection Grade

Insulation Class III
Version E16A352 and E16E352 : IP20
Version E16G352: IP65 resp. NEMA4

3.6. Connectors

Plug-In Cage-Clamp Connectors, type Phoenix Combicon FK-MLP1,5/...ST-3,5,
fitting for:

Conductor cross section solid min.: 0.2 mm²
Conductor cross section solid max.: 1.5 mm²
Conductor cross section stranded min.: 0.2 mm²
Conductor cross section stranded max.: 1.5 mm²
Conductor cross section stranded, with ferrule without plastic sleeve min.: 0.25 mm²
Conductor cross section stranded, with ferrule without plastic sleeve max.: 1.5 mm²
Conductor cross section stranded, with ferrule with plastic sleeve min.: 0.25 mm²
Conductor cross section stranded, with ferrule with plastic sleeve max.: 0.75 mm²
Conductor cross section acc. to AWG/kcmil min.: No. 24
Conductor cross section acc. to AWG/kcmil max: No. 16
Minimum AWG according to UL/CUL: 28
Maximum AWG according to UL/CUL: 16

3.7. Conformity to Standards

2006/42/EU
SIL3/IEC61508, DIN EN ISO 13849-1:2008 Cat 3 PL e, API 670, API 672
2006/95/EU, EN 61010-1,
2004/108/EU, EN 61000-6-2, EN 61000-6-4, IEC 611311-2

3.8. Dimensions of system E16A352

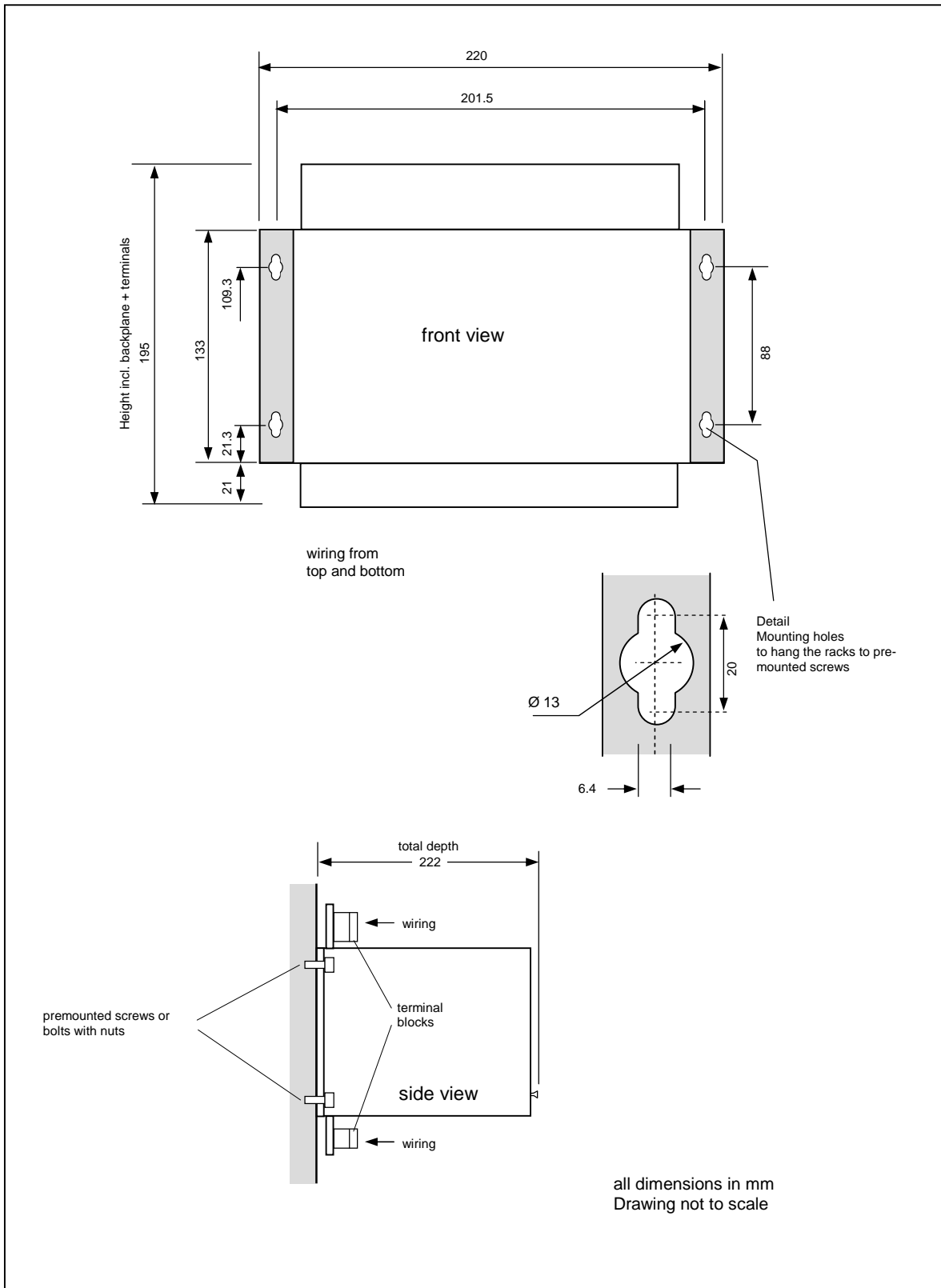

Figure 9: Dimensions of System E16A352

3.9. Dimensions of system E16E352

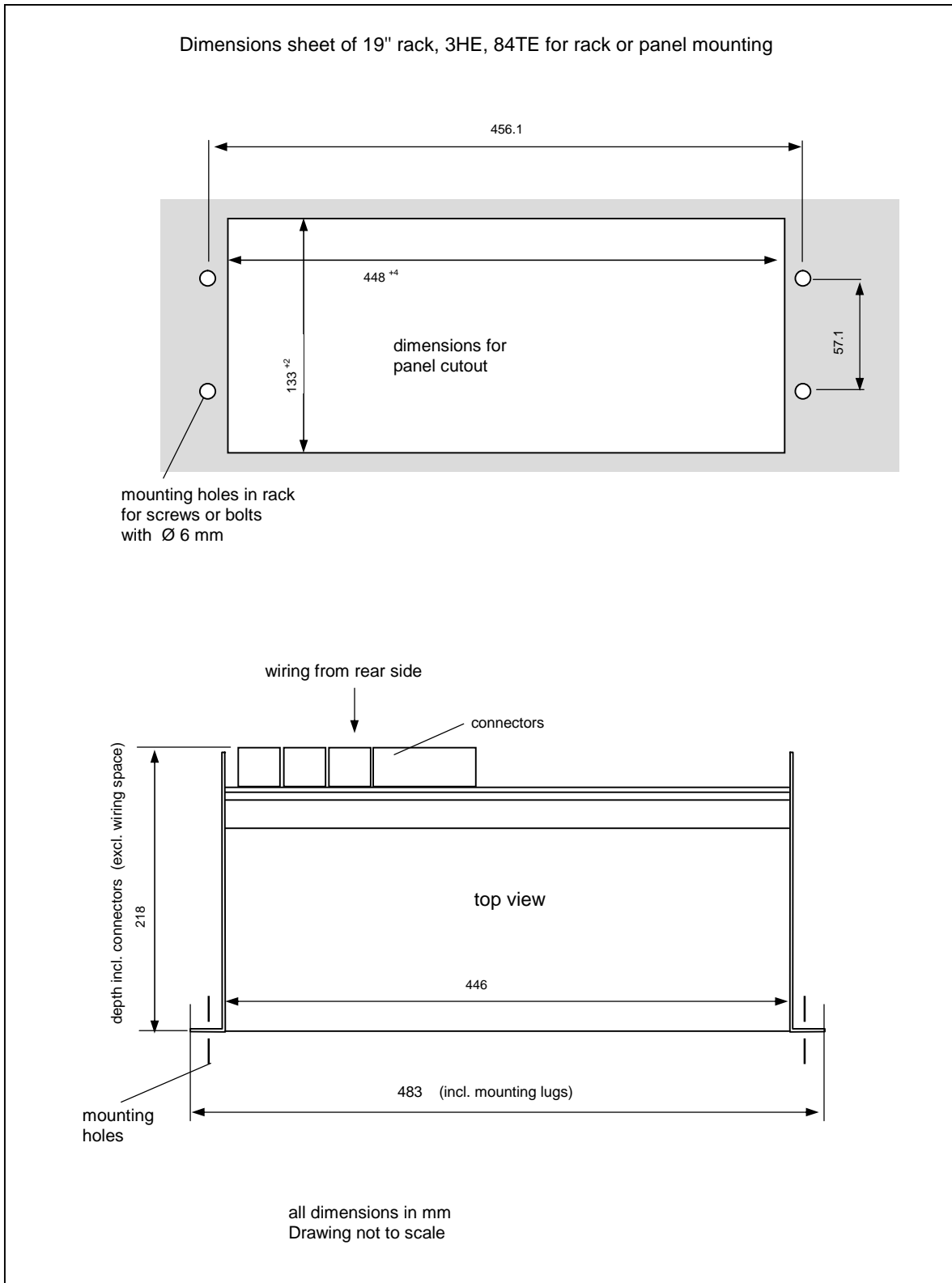

Figure 10: Dimensions of System E16E352

3.10. Dimensions and Features of E16G352 Enclosure

Overall Dimensions (including mounting lugs):

Height: 510 mm

Width: 410 mm

Depth: 270 mm

Glazed Window with size 360 by 410 mm

Material: Fiberglass reinforced plastic

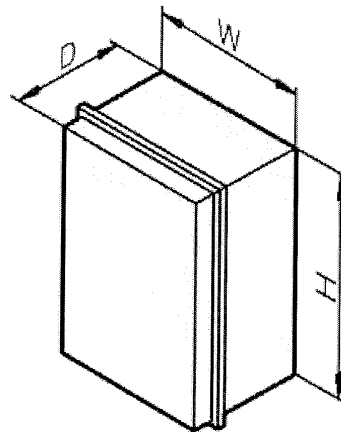

Figure 11: Dimensions of E16G352 Enclosure

3.11. Weight of E16x352

E16A352 : 3,0 kg

E16E352 : 3,7 kg

E16G352: 13,0 kg

4. Safety Notes for Installation and Operation

4.1. Safety Notes for Installation

This unit has been designed and inspected according to standards DIN EN 61010-1 (VDE 0411-1).

Observe these instructions and wiring diagrams carefully, to ensure this standards and safe operation of the machine.

The installation must be done only by adequately qualified personnel and with power supply switched off.

4.1.1. General Instructions

Specifically, connect the PE terminal 1.X1 to a safe ground potential.

Do not open the instrument. Connections and all programming are done from outside. When removing it from its enclosure however, from whatever reason, make sure that power is switched off.

The instrument may be installed in any position, but not in the immediate neighborhood of interfering sources.

Speed signal leads must be carefully shielded, and should not be run in bundles with power or relay control leads.

Each speed signal must have its own screen.

4.1.2. EMI

The unit complies with all relevant regulations, as determined by the Policy of the European Committee for Electrotechnical Standardization (CENELEC), for the Electromagnetic Compatibility (2004/108/EU). Testing and inspection has been performed according to Standards IEC 61000-4-2 and IEC 61326-3-2. Thereby, the product meets all requirements to be marked by the CE sign.

Specifically to be observed:

Terminals must be kept off all undue access.

Terminals must be protected against electrostatic discharge.

Power supply and all input and output leads must be protected overvoltage.

4.2. Safety Notes for Operation

4.2.1. Safety Notes for Commissioning

The commissioning must be done only by adequately qualified personnel and with power supply switched off.

On initial operation of the monitored machine the operator must ensure proper function of the measurement chains.

This includes checking of the correct speed display and of the trip release due to a real over-speed condition.

If voter inputs are used the correct trip release due to external trip condition must be verified.

The parameter settings must be documented and protected against unauthorized changes.

5. Description of Monitor E1668

5.1. Display and Frontside Operational Elements

5.1.1. Front View of Monitor E1668

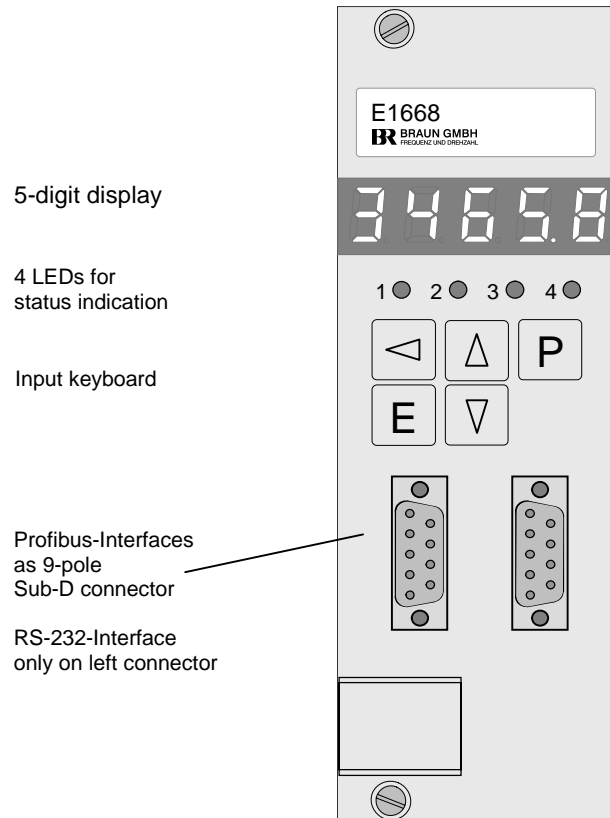

Figure 12: Front view of Monitor E1668

5.1.2. Status-LEDs

LED1	steady on:	Trip
LED2	steady on:	no Trip, SP1A is valid
	blinking:	SP1B is valid
LED3	steady on:	$n < SP3$
	blinking:	one only of three input channels measures zero speed
LED4	steady on:	$n > SP3$







5.1.3. Display during Test Procedures

FC-2 : External Trip-Release via Voter active
FC-3.1 : Trip-Line I is tested (Relay I to Trip-Condition)
FC-3.2 : Trip-Line II is tested (Relay II to Trip-Condition)
FC-3.4 : Trip-Line III is tested (Relay III to Trip-Condition)



SELF : Monitor self-test





5.1.4. Values accessible during normal operation

Values accessible during normal operation (Standard Display Mode):

- with key  the value of SP1
- with key  the value of SP2
- with key  and  together: maximum stored speed value
- with key  and  together: minimum stored speed value

Note:

- with key  Reset of stored minimum/maximum value
- with key  and  together: Reset of latched (and not persistent) alarms, if enabled

- with key  and  together: Toggle between Standard-Display Mode and Special Display Mode 1
- with key  and  together: Toggle between Standard-Display Mode and Special Display Mode 2

5.1.5. Display of Firmware Release State and CRC-Parameter-Checksum of Monitor E1668

With key  pressed longer as 5 seconds, the firmware release state and the CRC-Parameter-Checksum will be shown in a scrolled display:

- A.0327 (firmware ID)
- U._.xx (xx = firmware version number)
- D.uu._ (uu = day)
- D._vv._ (vv = month)
- D._.ww (ww = year of firmware release state)
- C.abcd (abcd = CRC-Parameter-Checksum)

5.1.6. Special Display Mode 1

Toggle between Standard and Special Display Mode 1 by pressing keys Δ and ∇ together. In Special Display Mode 1 the measured speed values of sensors A, B, C can be shown individually as well as the signal level of the main sensor.

Toggle between the four values with E .

The LED assigned to the specific speed value is blinking (see table).

with Monitor	LED assigned to			
	speed value of sensor: LED1 LED2 LED3			signal level (in xx.x volts) LED4
A	A	C	B	A
B	B	A	C	B
C	C	B	A	C

Note :

If signal level (LED4 blinking) is selected, without a key pressed the median signal value is displayed.

The maximum measured signal level is then displayed with key Δ .

The minimum measured signal level is then displayed with key ∇ .

Minimum, maximum and median values are dynamically updated with a sample rate of approx. 1 second.

5.1.7. Special Display Mode 2

Toggle between Standard and Special Display Mode 2 by pressing keys Δ and P together.

In Special Display Mode 2 LED1 and LED4 are blinking.

This display mode is only used for trouble shooting, if external signals are missing and the monitor displays the Event code E.0.4.0.0 .

5.1.8. Frontside Reset of Alarms and Event Codes

Resetting of (no longer valid) alarms and event codes is done by pressing keys E and \leftarrow (if enabled in step P00.02).

5.1.9. Data Interface

Two 9pole Sub-D for PROFIBUS (RS232 only on left connector).

Note:

For RS232, adapter L3D02 or cable L3D05 must be used

5.2. Functions of Monitor E1668

For a detailed description of the individual functions refer to chapter 8.

5.2.1. Speed Measurement

Each monitor receives the signal from the three sensors and calculates the speed from each signal. For the further evaluation it selects (depending on parameter settings) the calculated speed value derived of its own sensor or the mean value of all three speed values.

Speed calculation is done by measuring the time in between the pulses. The minimum measurement time is 5 milliseconds.

To compensate for an imperfect gear, a predivider may be introduced to reduce the signal frequency to 1 pulse per revolution.

5.2.2. Functions for Overspeed Protection

Overspeed protection is done by :

- Monitoring of Sensors
- Monitoring versus Lowspeed as protection versus incorrect mounting or fault of speed sensors.
- Monitoring versus overspeed

5.2.3. Functions for External Trip by Voters

Trip is released, if one of the voters detects an external trip condition.

Voters may be configured as 1oo2, 2oo2, 2oo3 or 3oo3. High or low Input-Level as trip condition and response time is selectable.

5.2.4. Selftest of Monitor

Selftest is performed at an interval of 2 hours. Execution of Selftest is signaled on display with message SELF. Selftest of the monitors are inhibited versus each other.

The Selftest routine includes

- CPU RAM-Test
- CPU EEPROM-Test
- CPU Command-Test
- CPU Register-Test
- Voter Signal-input-Test

If the Selftest detects a malfunction, the monitor is set to trip-status.

6. Description of Testinterface E1691

The Testinterface E1691 processes the signals trip-line test from the PLC to the Monitors and the trip status from the Monitors to the PLC.

The Test Interface supplies a constant test frequency to the Monitors, which use this frequency for their self test function.

The Testinterface releases the System Warning Alarm if:

- Minimum one Monitor detects a discrepancy at its voter inputs
- Minimum one Monitor detects a failed speed signal
- Minimum one Monitor has a malfunction
- Malfunction of Testinterface

7. Programming of the Monitors

7.1. Programming of the Monitors via Front Keyboard

Principle: Select a parameter via its ,name' **Pgg.ss**,
 in that **gg** : Parameter-group number and
ss : Step-number within the group,
 then display the value and alter if required.

Procedure:

Initiate programming phase by pressing keys **P** and **E** together; instead of the normal display P00.00. appears
 Select the group or step number with keys **Δ**, **∇**.
 Switch between Groups and Step Fields with the **◀**. key
 Current value of the Parameters is displayed with key **E**.
 Select active position with the **◀**. key
 Adjust the number in the active field with keys **Δ**, **∇**.
 Acknowledge and set with key **E**, Discard (original value remains) with key **P**.
 Return to operational mode with the **P** key. The display then returns to the current 'is' speed (with E1668) resp.
 to the current test-speed (with E1697)

See example below: Change parameter P01.01 from 2386 to 2387 or 2385.

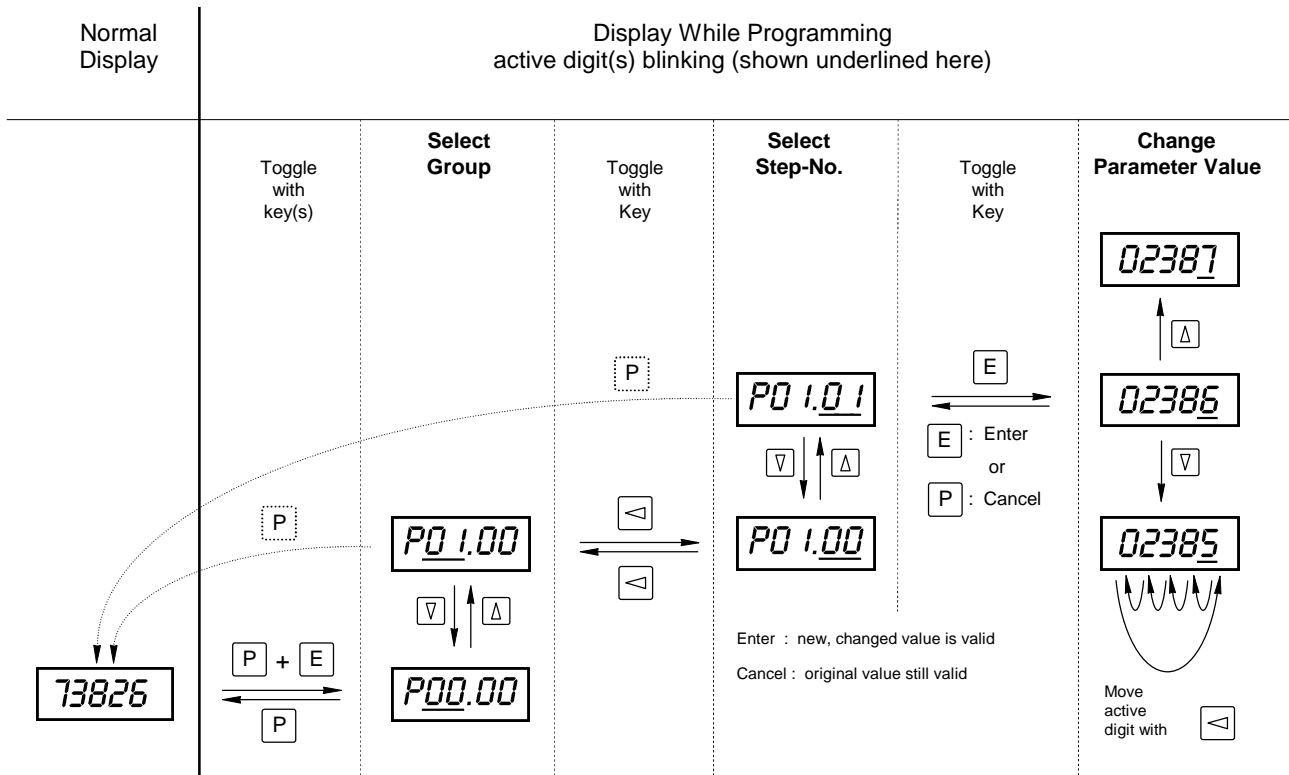

7.2. Programming of the Modules via RS232-Interface

1. adapter L3D02 with cable L3D03 by BRAUN

Note:

- Adapter L3D02 has male connectors on both sides.
- Cable L3D03 has female connectors to L3D02 and to PC.

or

2. customized cable with connections PC (female connector) to E16 (male connector):

PC pin 2	to	E16 pin 2
3	to	7
5	to	5

(of 9 pole Sub-D connectors)

Note:

- The RS232-Interface serves only for parameter programming purposes, not for transmission of current data. States, alarms and measurement data are transmitted via PROFIBUS-Interface only.

7.3. Default Values

If not specified otherwise, the unit is supplied with default values as listed in the summary of parameters. In process of installation, the setting of its parameters inevitably must be adapted to the correct values according its application.

8. Parameters of Monitor E1668

8.1. Summary of parameters and their default values

Param. No.	Default Value	Parameter Function
P00.xx		Code figure, Parameter Lock
P00.00	0000	Code figure
.01	0000	New code figure
.02	0	Parameter Lock : 0: locked / 1: enabled
.03	0	Front side Reset: 0: not possible / 1: possible
P01.xx		Input, Scaling
P01.00	0	Reserved for future applications
.01	10000	Value of nominal input frequency in Hz
.02	0	Decimals of speed value for SP2, SP3 PROFIBUS-Output
.03	10000	Nominal speed in RPM
.04	00001	Lower limit of the speed range
.05	001	Predivider (range 001 - 255)
.06	0	Reserved for future applications
.07	0	Decimals for acceleration
.08	01000	Maximum acceleration in XXXX or XXX.X RPM/sec
.09	1	No. of acceleration measurements included in calculation of SP1var
P02.xx		Display, Starter, Tests
P02.00	0	Reserved for future applications
.01	0.3	Display updating sequence (in x.x sec)
.02	000	Time elapse of starter phase (in xxx sec)
.03	1	Reserved for future application
.04	4	Sensor monitoring: 0: off / 1: on / 2: on, latched / 4: on, no trip
.05	1	Mode of sensor monitoring: 0 ... 7 (see table)
.06	1	Lowspeed Monitoring "n < SP2": 0 ... 4 (see table)
.07	5	Speed comparison test : 0 ... 5 (see table)
.08	030	Permissible Speed Difference between Sensors (in xxx RPM)
.09	05	Number of errors before reporting
.10	1	Monitor Warning Alarm at Trip: 0 ... 4 (see table)
.11	1	Latch Monitor Warning Alarm: 0: no / 1: yes, all alarms / 2: yes, first one only
P03.xx		Overspeed Alarm SP1
P03.00	00010	Setpoint SP1A in RPM
.01	05.0	Hysteresis bandwidth (XX.X % of. SP1)
.02	0	Alarm to be latched / energized or de-energized to trip: 0: no, de-energize / 1: yes, de-energize / 2: no, energize / 3: yes, energize
.03	00001	Setpoint SP1B in RPM
.04	0	Setpoint SP1var : 0: not active / 1: active
		Continued on next page

Param. No.	Default Value	Parameter Function
P04.xx		Low Speed Alarm SP2
P04.00	00015	Setpoint SP2 in RPM
.01	05.0	Hysteresis bandwidth (XX.X % of SP2)
.02	0	Fix value = 0, do not change
P05.xx		Alarm SP3
P05.00	00003	Setpoint SP3 in RPM
.01	05.0	Hysteresis bandwidth (XX.X % of SP3)
.02	1	Hysteresis position: 0: above / 1: below
.03	1	Relay state at "n > SP3" : 0 ... 3 (see table)
.04	0	Alarm state at sensor fault: 0: acc. to speed / 1: "n < SP" / 2: "n > SP"
.05	1	Setting of LEDs to status "n > SP3" : 0: LED3 on / 1: LED4 on
P06.xx		Eddy sensor
P06.00	00100	Reserved for future application
.01	00.0	Eddy sensor input check: input voltage upper limit in xx.x volts
.01	00.0	input voltage lower limit in xx.x volts
.03	00.0	current drain upper limit in xxx m
.04	00.0	current drain lower limit in xxx m
.05	0.0	Eddy sensor input hysteresis in x.x volts
P07.xx		Trip-Lines, Forward / Reverse Detection
P07.00	0	Trip-Lines Monitoring: 0: no / 1: yes
.01	0	Signal level Trip-Feedback: 0: low = Trip / 1: high = Trip
.02	1	Forward / Reverse Detection Input level: 0: low = forward / 1: high = forward
.03	1	Forward / Reverse relay state: 0: de-energized = forward / 1: energized = forward
.04	0	Reserved for future application
P08.xx		Analog Output
P08.00	10000	High end speed value
.01	00000	Low end speed value
.02	1	Zero level: 0: dead zero / 1: live zero
.03	0	Output level at sensor fault: 0: no change / 1: min / 2: max
.04	0	Output direction: 0: 0/4 ... 20 ma / 1: 20 ... 4/0 ma
.05	1	Output response to test-speed: 0: test-speed / 1: frozen
.06	0	Test of Analog Output value: 0: no / 1: yes
P09.xx		Reserved for future application
P09.00	0	Reserved for future application
P10.xx		Voter No. 1 and LO1
P10.00	0	Operation Mode: 0 ... 5 (see table)
.01	0	Input Truth Level: 0: high = Trip / 1: low = Trip
.02	0	Voting logic: 0: 1oo2 / 1: 2oo2 / 2: 2oo3 / 3: 3oo3
.03	0	Truth Time until Trip: 0 ... 7 (see table)
.04	0	Trip latched: 0: no / 1: yes
.05	0	Delay of Antivalence Alarm: 0 ... 9 (see table)
.06	00110	Value for setpoint SPV1
		Continued on next page

Param. No.	Default Value	Parameter Function
P11.xx		
Voter 2 and LO2		
P11.00	0	Operation Mode: 0 ... 5 (see table)
.01	0	Input Truth Level: 0: high = Trip / 1: low = Trip
.02	0	Voting logic: 0: 1oo2 / 1: 2oo2 / 2: 2oo3 / 3: 3oo3
.03	0	Truth Time until Trip: 0 ... 7 (see table)
.04	0	Trip latched: 0: no / 1: yes
.05	0	Delay of Antivalence Alarm: 0 ... 9 (see table)
.06	00120	Value for setpoint SPV2
P12.xx		
Voter 3 and LO3		
P12.00	0	Operation Mode: 0 ... 5 (see table)
.01	0	Input Truth Level: 0: high = Trip / 1: low = Trip
.02	0	Voting logic: 0: 1oo2 / 1: 2oo2 / 2: 2oo3 / 3: 3oo3
.03	0	Truth Time until Trip: 0 ... 7 (see table)
.04	0	Trip latched: 0: no / 1: yes
.05	0	Delay of Antivalence Alarm: 0 ... 9 (see table)
.06	00130	Value for setpoint SPV3
P13.xx		
Voter 4 and LO4		
P13.00	0	Operation Mode: 0 ... 5 (see table)
.01	0	Input Truth Level: 0: high = Trip / 1: low = Trip
.02	0	Voting logic: 0: 1oo2 / 1: 2oo2 / 2: 2oo3 / 3: 3oo3
.03	0	Truth Time until Trip: 0 ... 7 (see table)
.04	0	Trip latched: 0: no / 1: yes
.05	0	Delay of Antivalence Alarm: 0 ... 9 (see table)
.06	00140	Value for setpoint SPV4
P14.xx		
Voter 5 and LO5		
P14.00	0	Operation Mode: 0 ... 5 (see table)
.01	0	Input Truth Level: 0: high = Trip / 1: low = Trip
.02	0	Voting logic: 0: 1oo2 / 1: 2oo2 / 2: 2oo3 / 3: 3oo3
.03	0	Truth Time until Trip: 0 ... 7 (see table)
.04	0	Trip latched: 0: no / 1: yes
.05	0	Delay of Antivalence Alarm: 0 ... 9 (see table)
.06	00150	Value for setpoint SPV5
P15.xx		
Voter 6 and LO6		
P15.00	0	Operation Mode: 0 ... 5 (see table)
.01	0	Input Truth Level: 0: high = Trip / 1: low = Trip
.02	0	Voting logic: 0: 1oo2 / 1: 2oo2 / 2: 2oo3 / 3: 3oo3
.03	0	Truth Time until Trip: 0 ... 7 (see table)
.04	0	Trip latched: 0: no / 1: yes
.05	0	Delay of Antivalence Alarm: 0 ... 9 (see table)
.06	00160	Value for setpoint SPV6
Continued on next page		

Param. No.	Default Value	Parameter Function
P16.xx		Reserved for future application
P16.00	0	Reserved for future application
.01	0	Reserved for future application
.02	0	Reserved for future application
.03	0	Reserved for future application
.04	0	Reserved for future application
.05	0	Reserved for future application
.06	00000	Reserved for future application
P17.xx		Data Interface
P17.00	016	PROFIBUS-Interface Device no.
.01	0	Address Offset for redundant Profibus Interface

Parameter Group P00.xx of Monitor E1668 Code Figure, Parameter Lock, Frontside Reset of Alarms	
Parameter No. Meaning of Parameter Setting Range of Parameter	Description of Parameters and their Settings
P00.00 Code Figure Range: 0000 .. 9999	If the parameters are locked (see P00.02), the code figure must be entered prior to any change of other parameters. If the code figure is not correct, -E 1- is displayed. Without code figure and P00.02 : 0 the values of all parameters may be inspected, but not changed.
P00.01 New Code Figure Range: 0000 .. 9999	A new code figure may be set in P00.01. Then it replaces the previous one.
P00.02 Parameter Lock Range: 0 .. 1	Setting 0 : Parameters are locked, change only possible with code figure 1 : Parameters unlocked, change of parameter values possible
P00.03 Frontside Reset of Alarms Range: 0 .. 1	Setting 0 : Frontside reset of alarms not possible 1 : Frontside reset of alarms possible with keys E and ◀ .

Parameter Group P01.xx of Monitor E1668 Input Scaling and Measurement Configuration	
Parameter No. Meaning of Parameter Setting Range of Parameter	Description of Parameters and their Settings
P01.00 Reserved for future applications	
	<p>Description of Scaling: Scaling defines the relationship between the input signal frequency (in terms of Hz), and the corresponding display (in terms of RPM). Of course, they must refer to the same operation level. This reference point is recommended close to the high end of the intended operation range. In later operation, however, it may be overrun without error.</p> <p>Example: 1500 Hz corresponds to 3000 RPM : <div style="margin-left: 150px;">⇒ Step P01.01 : setting 01500 Step P01.03 : setting 03000</div></p>
P01.01 Nominal Input Frequency [Hz] Range: 00001 .. 99999	See description of Scaling.
P01.02 Decimals for P01.04, P04.00, P05.00 and for PROFIBUS Speed Data Output Range: 0 .. 1	Setting 0 : Setting range for P01.04, P04.00, P05.00 : 00001 to 99999 RPM 1 : Setting range for P01.04, P04.00, P05.00 : 0000.1 to 9999.9 RPM
P01.03 Nominal speed [RPM] Range: 00001 .. 99999	See description of Scaling.
P01.04 Lower Limit of the Speed Range Range as defined in P01.02	If the monitored speed falls below the value entered here the measured value is given as 0 both for the display and the alarms. The lower limit of the speed range is entered in units of RPM.

Parameter Group P01.xx (continued) of Monitor E1668 Measurement Configuration	
Parameter No. Meaning of Parameter Setting Range of Parameter	Description of Parameters and their Settings
P01.05 Predivider Range: 001 .. 255	The predivider is used only if the variable setpoint SP1var is active (P03.04 = 1). The predivider must then be set to the number of teeth of the gear wheel. The acceleration measurement is extended over one full rotation of the machine. Note: The predivider applies only to the primary measurement input. The two other measurement channels are not affected by the predivider.
P01.06 Reserved for future application	
P01.07 Decimals for acceleration Range: 0 .. 1	Setting 0 : setting of acceleration in XXXX RPM/sec 1 : setting of acceleration in XXX.X RPM/sec
P01.08 Maximum acceleration of the machine [RPM/sec] Range: 00001 .. 99999 resp. 0000.1 .. 9999.9	Setting is done in RPM/sec. Value must be set to the maximum possible acceleration (dN/dt max) of the machine in the worst case scenario. See also description of step P03.04.
P01.09 No of acceleration measurements included in calculation of SP1var Range: 1 .. 5	Recommended value is 1 or 2 measurements (equals to a measurement time of 20 or 40 milliseconds at a speed of 3000 RPM). More measurements included will improve the stability of the calculated setpoint SP1var, but also result in a delayed update rate.

Parameter Group P02.xx of Monitor E1668 Display, Starter time, Sensor Failure Monitoring	
Parameter No. Meaning of Parameter Setting Range of Parameter	Description of Parameters and their Settings
P02.00 Reserved for future application	
P02.01 Display updating sequence Range: 0.1 .. 9.9 [sec]	The display may have its own independent up-dating sequence, different from the response time used by other functions - again in the interests of stabilized and legible readings. Set the parameter to the time required in steps of 0.1 sec. Recommended value is 0.3 sec. The display value is determined by the duration of a cycle sequence. The rapid response of the alarms is not influenced by this procedure.
P02.02 Starter time period Range: 000 .. 999 [sec]	This step sets the starter time period (duration). The starter phase state for SP2 lasts from the beginning of the external starter signal plus the programmed time elapse following its end.
P02.03 Reserved for future application	
P02.04 Sensor Monitoring (Current and Signal Level) Range: 0 .. 4	A sensor fault will be reported according to the designated parameters and, if configured, latched until the reset is activated. Setting 0 : Monitoring disabled 1 : Not permissible 2 : Fault reported + Trip release, latched till reset 3 : Not permissible 4 : Fault reported without trip release (recommended setting)
P02.05 Mode of Sensor Monitoring Range: 0 .. 3	Setting 0 : Without monitoring (see Note 3) 1 : Checks sensor current drain 2 : Checks signal voltage level at stand still (see Note 1) 3 : Current drain and voltage level 4 : Inductive sensor (MPU) 5 : Reserved for future use 6 : Eddy sensor voltage level (see Note 2) 7 : Eddy sensor voltage level and current drain (see Note 2) Note 1: The voltage level check is only possible with Braun-sensor type A5S... . In this instance even at stand still a defective sensor or supply cable can be detected. Note 2: The signal voltage level (and current drain) is compared versus max/min-values as set in P06.01 to P06.04. Note 3: Selection of Setting 0 makes Step P02.04 meaningless.

Parameter Group P02.xx (continued) of Monitor E1668 Sensor Failure Monitoring	
Parameter No. Meaning of Parameter Setting Range of Parameter	Description of Parameters and their Settings
P02.06 Lowspeed Monitoring "n < SP2" Range: 0 .. 4	<p>Safety Note: The Lowspeed Monitoring "n < SP2" is the only comprehensive protection versus a systematic fault of any type of speed sensor (no speed signal from sensor at running machine). Setting of P02.06 = 0 is only allowed for test purposes during start-up of the machine. In normal operation P02.06 must be set to a value of 1 or 2 or 3 or 4.</p> <p>Function of Lowspeed Monitoring "n < SP2": Following the end of the Starter phase (Start-Up Bridging) the measured speed must exceed the value set for SP2. If the measured speed n is then lower than SP2, trip is released.</p> <p>Function of Starter Plausibility Check: If</p> <ul style="list-style-type: none"> • starter condition is true • and plausibility check is on • and speed exceeds 50% of overspeed setpoint SP1A <p>then Monitor Warning Alarm is released by plausibility check and error code E.3.0.1.0 is displayed.</p> <p>Setting 0 : Monitoring switched off (not permissible, see safety note above) 1 : Trip and Alarm till rectified, starter plausibility check on 2 : Trip and Alarm latched, starter plausibility check on 3 : Trip and Alarm, till rectified / starter plausibility check off 4 : Trip and Alarm latched / starter plausibility check off</p>

Parameter Group P02.xx (continued) of Monitor E1668 Sensor Failure Monitoring	
Parameter No. Meaning of Parameter Setting Range of Parameter	Description of Parameters and their Settings
P02.07 Speed Comparison Evaluation Mode Range: 0 .. 5	<p>Speed comparison of the 3 sensors enables:</p> <ul style="list-style-type: none"> • Detection of incorrect installation of the sensor (distance from the tooth wheel too large or wrong position) even during the start-up bridging phase. • Detection of a fading function of a sensor during normal operation. <p>Functionality: Each Monitor has three measuring channels and receives the signals of all three sensors.</p> <p>Setting</p> <ul style="list-style-type: none"> 0 : only the primary sensor will be evaluated; no redundancy 1 : Trip is released if primary sensor fault is detected 2 : only error message is released if primary sensor fault is detected, but only speed value of primary sensor is used for further evaluation 3 : not permissible 4 : only error message is released if primary sensor fault is detected, but the mean value of the three speed values is used for further evaluation 5 : same as setting 4, but a trip released due to deviation is latched <p>Setting 1 or 2 or 4 or 5 :</p> <p>During machine operation each Monitor compares its sensor input with those of its two neighbors. If the measured speed value of its own (primary) sensor in comparison with its two neighbors produces a discrepancy exceeding the tolerance level set at P02.08, the monitor's primary sensor will be reported as faulty.</p> <p>However, should all three measured speed values deviate from each other for more than the specified tolerance, the monitor will release trip.</p> <p>Note: Settings P02.07 = 4 or 5 avoids a trip release caused by a sensor fault during the automatic test procedure and are recommended settings.</p> <p>Example: Monitor A is tested for overspeed, at the same time the signal from sensor B drops out. Monitor B reports an error, but continues to evaluate the signals from sensors A and C.</p>

Parameter Group P02.xx (continued) of Monitor E1668 Sensor Failure Monitoring																															
Parameter No. Meaning of Parameter Setting Range of Parameter	Description of Parameters and their Settings																														
P02.08 Permissible Speed Difference between Sensors [RPM] Range: 001 .. 999	Value for the permissible difference in RPM between the speed measurement of the primary sensor and that of the other two sensors before a fault is detected. Note: Primary sensor is the sensor the monitor supplies with power.																														
P02.09 Number of tests until alarm Range: 01 .. 99	Number of consecutively failed speed comparison tests which may occur before an error message is issued. Note: At speeds lower than 50% of the nominal speed, the number of tests is automatically increased to avoid incorrect alarms during acceleration phase of the machine. Example for Setting of P02.07 = 4: P02.08 = 030 (permissible difference between measured values = 30 RPM) P02.09 = 5 (Number of consecutive errors till error message issued) With the example above an error message will be issued when the speed value of the primary sensor deviates by 30 RPM from the two other measured sensors five measurements in succession. When all three measurements of one monitor between themselves differ by more than 30 RPM (measurement of sensor A = 6031 RPM, of sensor B = 6000 RPM, of sensor C = 5969 RPM), the monitor will release trip.																														
P02.10 Monitor Warning Alarm also at Trip Condition Range: 0 .. 4	Setting depends on how the alarm is used according the specific application for detection of SOE (sequence of events). <table border="1" data-bbox="582 1317 1327 1615"> <thead> <tr> <th>Setting</th> <th>Alarm at Overspeed-Trip</th> <th>Alarm at Voter-Trip</th> <th>Alarm at Trip due to Trip-Line-Monitoring</th> <th>Alarm at Lowspeed-Trip</th> </tr> </thead> <tbody> <tr> <td>0</td> <td>No</td> <td>No</td> <td>Yes</td> <td>Yes</td> </tr> <tr> <td>1</td> <td>Yes</td> <td>Yes</td> <td>Yes</td> <td>Yes</td> </tr> <tr> <td>2</td> <td>No</td> <td>No</td> <td>No</td> <td>Yes</td> </tr> <tr> <td>3</td> <td>Yes</td> <td>Yes</td> <td>No</td> <td>Yes</td> </tr> <tr> <td>4</td> <td>No</td> <td>No</td> <td>No</td> <td>No</td> </tr> </tbody> </table> Note: The Monitor Warning Alarm is always released in case of detected sensor fault.	Setting	Alarm at Overspeed-Trip	Alarm at Voter-Trip	Alarm at Trip due to Trip-Line-Monitoring	Alarm at Lowspeed-Trip	0	No	No	Yes	Yes	1	Yes	Yes	Yes	Yes	2	No	No	No	Yes	3	Yes	Yes	No	Yes	4	No	No	No	No
Setting	Alarm at Overspeed-Trip	Alarm at Voter-Trip	Alarm at Trip due to Trip-Line-Monitoring	Alarm at Lowspeed-Trip																											
0	No	No	Yes	Yes																											
1	Yes	Yes	Yes	Yes																											
2	No	No	No	Yes																											
3	Yes	Yes	No	Yes																											
4	No	No	No	No																											
P02.11 Latching of Monitor Warning Alarm and Event Display Range: 0 .. 2	The Monitor Warning Alarm and the Event Display can be latched. Setting 0 : no 1 : yes, in this case all occurring event are shown in the display as combinations 2 : yes, in this case only the first occurring event is displayed																														

Parameter Group P03.xx of Monitor E1668 Overspeed Alarm SP1	
Parameter No. Meaning of Parameter Setting Range of Parameter	Description of Parameters and their Settings
P03.00 Overspeed Setpoint SP1A Range: 00001 .. 99999	The numerical value for the setpoint is set in terms of RPM.
P03.01 Alarm Hysteresis Width Range: 00.1 .. 99.9	<p>Hysteresis of Overspeed Setpoint</p> <p>The hysteresis is the margin between condition "excess" (>) and "no excess" (<), defined by its bandwidth.</p> <p>Width of the hysteresis</p> <p>The width of hysteresis is set as a percentage of the switching point. The position of the hysteresis for SP1 is determined beneath the setpoint.</p> <p>Example: With 5% Hysteresis and a setpoint of 10000 RPM an overspeed alarm is issued once 10000 RPM is exceeded and ceases should the speed drop below 9500 RPM.</p> <p>Note: The hysteresis is always calculated for SP1A. If SP1B is used and the alarm is not latched, hysteresis must be chosen that</p> <ul style="list-style-type: none"> • it is big enough to include SP1B to avoid bouncing of the trip relays • it is small enough to that the return point is not lower than normal operating speed. <p>Example: SP1A=3240 RPM, SP1B=3090 RPM, normal operating speed=3000 RPM.</p> <p>Then hysteresis must be minimum $(3240-3090)/3240 = 4.7\%$ and maximum $(3240-3000)/3000 = 7.9\%$.</p>
P03.02 Latching of Overspeed Alarm/ Energize or de-energize to Trip Range: 0 .. 3	<p>The overspeed alarm can be latched until externally reset.</p> <p>The trip relays can be programmed to energize or to de-energize to trip (released by Overspeed or externally via Voter) condition.</p> <p>Setting</p> <p>0 : alarm not latched, trip relays de-energize to trip 1 : alarm latched, trip relays de-energize to trip 2 : alarm not latched, trip relays energize to trip 3 : alarm latched, trip relays energize to trip</p>
P03.03 Overspeed Setpoint SP1B Range: 00001 .. 99999	The numerical value for the setpoint is set in terms of RPM. SP1B is always valid as long as the input „SP1B valid" is true.

Parameter Group P03.xx (continued) of Monitor E1668
Overspeed Alarm SP1

Parameter No. Meaning of Parameter Setting Range of Parameter	Description of Parameters and their Settings														
<p>P03.04 Overspeed Setpoint SP1var not active / active Range: 0 .. 1</p> <p>Attention: If P03.04 = 1: The value of SP1A (P03.00) must not be lower than the value of SP1B (P03.03), else SP1B will always be valid during acceleration phase.</p>	<p>Setting 0 : overspeed setpoint SP1var is not active 1 : overspeed setpoint SP1var is active</p> <p>If the overspeed setpoint SP1var is not active, then SP1A is valid (respective SP1B as long as the input "SP1B valid" is true). If the overspeed setpoint SP1var is active, it is calculated depending on the measured acceleration in between the limits of SP1A and SP1B. If acceleration $dN/dt = 0$, then $SP1var = SP1A$. If acceleration $dN/dt = dN/dt \text{ max}$, then $SP1var = SP1B$.</p> <p>Example for values of SP1var: $dN/dt \text{ max} = 300 \text{ RPM/sec}$ $SP1A = 3240 \text{ RPM}$ (at acceleration rate of 0 RPM/sec) $SP1B = 3090 \text{ RPM}$ (at acceleration rate of 300 RPM/sec)</p> <table border="1" data-bbox="598 969 1342 1294"> <thead> <tr> <th>measured acceleration</th> <th>calculated value SP1var</th> </tr> </thead> <tbody> <tr> <td>300 RPM/sec</td> <td>3090 RPM</td> </tr> <tr> <td>240 RPM/sec</td> <td>3120 RPM</td> </tr> <tr> <td>180 RPM/sec</td> <td>3150 RPM</td> </tr> <tr> <td>120 RPM/sec</td> <td>3180 RPM</td> </tr> <tr> <td>60 RPM/sec</td> <td>3210 RPM</td> </tr> <tr> <td>0 RPM/sec</td> <td>3240 RPM</td> </tr> </tbody> </table> <p>See also graph below</p>	measured acceleration	calculated value SP1var	300 RPM/sec	3090 RPM	240 RPM/sec	3120 RPM	180 RPM/sec	3150 RPM	120 RPM/sec	3180 RPM	60 RPM/sec	3210 RPM	0 RPM/sec	3240 RPM
measured acceleration	calculated value SP1var														
300 RPM/sec	3090 RPM														
240 RPM/sec	3120 RPM														
180 RPM/sec	3150 RPM														
120 RPM/sec	3180 RPM														
60 RPM/sec	3210 RPM														
0 RPM/sec	3240 RPM														

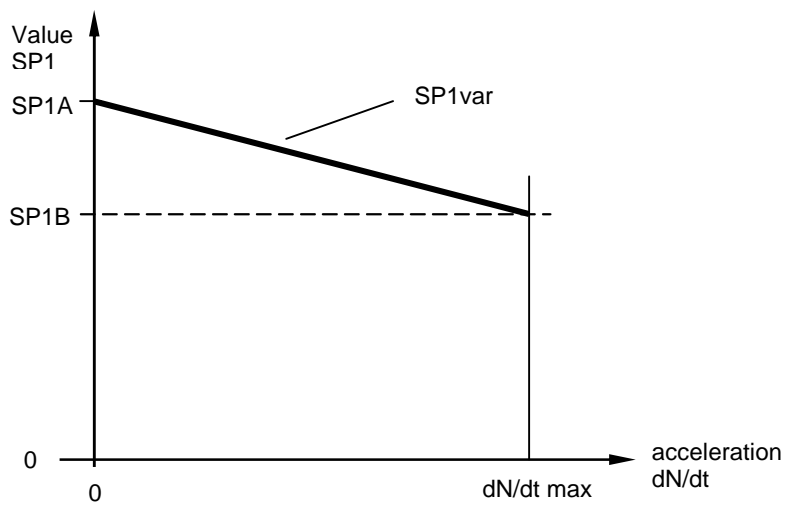

Figure 13:
 SP1 as a variable
 of the acceleration

Parameter Group P04.xx of Monitor E1668 Lowspeed Alarm SP2	
Parameter No. Meaning of Parameter Setting Range of Parameter	Description of Parameters and their Settings
P04.00 Lowspeed Setpoint SP2 Range: 00001 .. 99999	The numerical value for the setpoint is expressed as RPM.
P04.01 Alarm Hysteresis Width Range: 00.1 .. 99.9	The hysteresis is the margin between condition "excess" (>) and "no excess" (<), defined by its bandwidth. The width of hysteresis is set as a percentage of the switching point. The position of the hysteresis of SP2 is determined above the setpoint. Example: With 5% Hysteresis and a setpoint of 100 RPM a Lowspeed alarm is issued once speed drops below 100 RPM and ceases once speed exceeds 105 RPM.
P04.02 Fix value = 0, do not change	

Parameter Group P05.xx of Monitor E1668 Alarm SP3	
Parameter No. Meaning of Parameter Setting Range of Parameter	Description of Parameters and their Settings
P05.00 Setpoint SP3 Range: 00001 .. 99999	The numerical value for the setpoint is expressed as RPM.
P05.01 Alarm Hysteresis Width Range: 00.1 .. 99.9	The hysteresis is the margin between condition "excess" (>) and "no excess" (<), defined by its bandwidth. The width of hysteresis is set as a percentage of the switching point.
P05.02 Hysteresis position Range: 0 .. 1	The hysteresis band for SP3 may be placed above or below setpoint. Setting 0 : Hysteresis above SP3 1 : Hysteresis below SP3
P05.03 Relay State at n > SP3 Range: 0 ... 3	Setting 0 : Relay energized if n > SP3 1 : Relay de-energized if n > SP3 2 : Relay energized if n > SP3, output frozen at test 3 : Relay de-energized if n > SP3, output frozen at test
P05.04 Alarm State at Sensor Error Condition Range: 0 .. 2	If a sensor fault is detected, alarm SP3 can be forced into a defined state. Setting 0 : Alarm SP3 according to measured rotational speed 1 : Alarm SP3 forced to state n < SP3 2 : Alarm SP3 forced to state n > SP3
P05.05 Status of LEDs 3 and 4 for Alarm n > SP3 Range: 0 .. 1	Assignment LED (red or green) to alarm state n > SP3. Setting 0 : LED3 (green) on at n > SP3 1 : LED4 (red) on at n > SP3

Parameter Group P07.xx of Monitor E1668 Trip-Line-Monitoring, Rotational Direction Output	
Parameter No. Meaning of Parameter Setting Range of Parameter	Description of Parameters and their Settings
P07.00 Trip-Line-Monitoring Range: 0 .. 1	If activated the Monitor checks the output of the Trip-Lines. If two or three Trip-Lines indicate trip condition the monitor moves to trip status (Trip Lock Function). Following the reset signal the monitor releases the trip state for one second. Within this time the feedback signal must respond correctly, otherwise the monitor returns to trip status. Setting 0 : Trip-Line-Monitoring not active 1 : Trip-Line-Monitoring active, with response time until trip = 50 msec 2 : Trip-Line-Monitoring active, with response time until trip = 3 msec
P07.01 Trip-Line Level at Trip-Status Range: 0 .. 1	Setting 0 : Low Level at Trip-Status (relays de-energized to Trip) 1 : High-Level at Trip-Status (relays energized to Trip)
P07.02 Signal-Input Level for Rotational Direction Detection Range: 0 .. 1	Setting 0 : Signal level low is assigned to forward motion 1 : Signal level high is assigned to forward motion
P07.03 Relay State for status forward motion Range: 0 .. 1	Setting 0 : Relay de-energized at status forward motion 1 : Relay energized at status forward motion
P07.04 Reserved for future application. Fix value 0	

Parameter Group P08.xx of Monitor E1668 Analog Output	
Parameter No. Meaning of Parameter Setting Range of Parameter	Description of Parameters and their Settings
P08.00 High End of Analog Output Range: 00001 .. 99999	The high end defines the speed (in terms of RPM) at which the analog output delivers 20 mamps (with P08.04 = 0) (resp. 0 / 4 mamps with P08.04 = 1).
P08.01 Low End of Analog Output Range: 00000 .. 99999	The low end defines the speed (in terms of RPM) at which the analog output delivers 0 resp. 4 mamps (with P08.04 = 0) (resp. 20 mamps with P08.04 = 1).
P08.02 Analog Output Zero Level Range: 0 .. 1	Setting 0 : without live zero (0..20 mamps) 1 : with live zero (4..20 mamps)
P08.03 Output Level at Sensor Fault Range: 0 .. 1	Setting 0 : no change of output 1 : output goes to < 0 mamps 2 : output goes to >20,8 mamps
P08.04 Direction of Analog Output Range: 0 .. 1	Setting 0 : output is increasing with increasing speed (0/4 ...20 mamps) 1 : output is decreasing with increasing speed (20....4/0 mamps)
P08.05 Output Response at Test-speed Range: 0 .. 1	Setting 0 : output follows test-speed 1 : output is frozen (on last value before test starts) during test-speed
P08.06 Test of Analog Output Value Range: 0 .. 1	Analog output may be checked for short circuit or no load or its correct output, detected via integrated control feedback. Setting 0 : output value is not tested (mandatory with versions E1668.0xx respective E1668.1xx) 1 : value of output is tested (only possible with versions E1668.2xx) With setting 1 the analog output is rated SIL3/IEC61508. If a fault is detected, the analog output circuit is switched to high ohmic state, event code E.3.0.2.0 (at external fault) or E.3.0.2.1 (at internal fault = monitor must be replaced) is displayed and Monitor Warning Alarm signalized.

Parameter Group P09.xx of Monitor E1668 Reserved for future application	
Parameter No. Meaning of Parameter Setting Range of Parameter	Description of Parameters and their Settings
P09.00 Reserved for future application	

Parameter Group P10.xx of Monitor E1668 Voter 1 and Logic Output LO1																																					
Parameter No. Meaning of Parameter Setting Range of Parameter	Description of Parameters and their Settings																																				
P10.00 Operation mode Range: 0 .. 5	Setting 0 : Voter inactive 1 : Voter always active (over entire speed range) 2 : Voter only active, if n > SPV1 3 : Voter only active, if n < SPV1 4 : Voter inactive, output LO1 low, if n > SPV1 5 : Voter inactive, output LO1 high, if n > SPV1																																				
P10.01 Input Truth Level Range: 0 .. 1	Setting 0 : high level at inputs is assigned to trip condition 1 : low level at inputs is assigned to trip condition																																				
P10.02 Voting Logic Range: 0 .. 3	Selectable Voting Logics are: <ul style="list-style-type: none"> • 1oo2 : trip is released if 1 of 2 inputs signalizes trip condition • 2oo2 : trip is released if 2 of 2 inputs signalize trip condition • 2oo3 : trip is released if 2 of 3 inputs signalize trip condition • 3oo3 : trip is released if 3 of 3 inputs signalize trip condition Setting 0 : 1oo2 (only inputs 1 and 2 of voter 1 are monitored) 1 : 2oo2 (only inputs 1 and 2 of voter 1 are monitored) 2 : 2oo3 (all three inputs of voter 1 are monitored) 3 : 3oo3 (all three inputs of voter 1 are monitored)																																				
P10.03 Truth Time until Trip Range: 0 .. 7	If the trip signal is shorter than the minimum truth time, the signal is not valid (anti bouncing filter). If the signal is longer than the maximum truth time, the signal is valid and trip is released Note: Signal truth times in between min. and max. may release trip. Maximum response time until trip-lines go to trip status is maximum truth time + 3 milliseconds.	<table border="1"> <thead> <tr> <th rowspan="2">Setting</th> <th colspan="2">Truth time (Trip after)</th> </tr> <tr> <th>min.</th> <th>max.</th> </tr> </thead> <tbody> <tr><td>0</td><td>3 msec</td><td>6 msec</td></tr> <tr><td>1</td><td>6 msec</td><td>9 msec</td></tr> <tr><td>2</td><td>12 msec</td><td>16 msec</td></tr> <tr><td>3</td><td>24 msec</td><td>28 msec</td></tr> <tr><td>4</td><td>48 msec</td><td>52 msec</td></tr> <tr><td>5</td><td>96 msec</td><td>102 msec</td></tr> <tr><td>6</td><td>192 msec</td><td>202 msec</td></tr> <tr><td>7</td><td>384 msec</td><td>400 msec</td></tr> <tr><td>8</td><td>768 msec</td><td>800 msec</td></tr> <tr><td>9</td><td>1570 msec</td><td>1600 msec</td></tr> </tbody> </table>	Setting	Truth time (Trip after)		min.	max.	0	3 msec	6 msec	1	6 msec	9 msec	2	12 msec	16 msec	3	24 msec	28 msec	4	48 msec	52 msec	5	96 msec	102 msec	6	192 msec	202 msec	7	384 msec	400 msec	8	768 msec	800 msec	9	1570 msec	1600 msec
Setting	Truth time (Trip after)																																				
	min.	max.																																			
0	3 msec	6 msec																																			
1	6 msec	9 msec																																			
2	12 msec	16 msec																																			
3	24 msec	28 msec																																			
4	48 msec	52 msec																																			
5	96 msec	102 msec																																			
6	192 msec	202 msec																																			
7	384 msec	400 msec																																			
8	768 msec	800 msec																																			
9	1570 msec	1600 msec																																			
P10.04 Trip by Voter 1 latched Range: 0 .. 1	Setting 0 : trip by voter 1 is not latched 1 : trip by voter 1 is latched until reset																																				

<p>P10.05 Delay of Antivalence Alarm Range: 0 .. 9</p>	<p>To avoid unnecessary Antivalence Alarms due to shifted trip release signals at the voter inputs a delay may be introduced. Antivalence alarm will then be released only if the time shift between the signals exceeds the set delay.</p> <p>Setting</p> <ul style="list-style-type: none"> 0 : no delay 1 : delay = 100 milliseconds 2 : delay = 500 milliseconds 3 : delay = 1 second 4 : delay = 2 seconds 5 : delay = 3 seconds 6 : delay = 5 seconds 7 : delay = 15 seconds 8 : delay = 30 seconds 9 : delay = 60 seconds <p>Note: The input signals will be monitored for antivalence only, if the voter is active.</p>
<p>P10.06 Setpoint SPV1 Range: 00001 .. 99999 [RPM]</p>	<p>Depending on setting of P10.00, SPV1 controls the activity of voter 1 or controls directly the output LO1. SPV1 is set in terms of RPM.</p>

Parameter Group P11.xx of Monitor E1668 Voter 2 and Logic Output LO2																																					
Parameter No. Meaning of Parameter Setting Range of Parameter	Description of Parameters and their Settings																																				
P11.00 Operation mode Range: 0 .. 5	Setting 0 : Voter inactive 1 : Voter always active (over entire speed range) 2 : Voter only active, if n > SPV2 3 : Voter only active, if n < SPV2 4 : Voter inactive, output LO2 low, if n > SPV2 5 : Voter inactive, output LO2 high, if n > SPV2																																				
P11.01 Input Truth Level Range: 0 .. 1	Setting 0 : high level at inputs is assigned to trip condition 1 : low level at inputs is assigned to trip condition																																				
P11.02 Voting Logic Range: 0 .. 3	Selectable Voting Logics are: <ul style="list-style-type: none"> • 1oo2 : trip is released if 1 of 2 inputs signalizes trip condition • 2oo2 : trip is released if 2 of 2 inputs signalize trip condition • 2oo3 : trip is released if 2 of 3 inputs signalize trip condition • 3oo3 : trip is released if 3 of 3 inputs signalize trip condition Setting 0 : 1oo2 (only inputs 1 and 2 of voter 2 are monitored) 1 : 2oo2 (only inputs 1 and 2 of voter 2 are monitored) 2 : 2oo3 (all three inputs of voter 2 are monitored) 3 : 3oo3 (all three inputs of voter 2 are monitored)																																				
P11.03 Truth Time until Trip Range: 0 .. 7	If the trip signal is shorter than the minimum truth time, the signal is not valid (anti bouncing filter). If the signal is longer than the maximum truth time, the signal is valid and trip is released Note: Signal truth times in between min. and max. may release trip. Maximum response time until trip-lines go to trip status is maximum truth time + 3 milliseconds.	<table border="1"> <thead> <tr> <th rowspan="2">Setting</th> <th colspan="2">Truth time (Trip after)</th> </tr> <tr> <th>min.</th> <th>max.</th> </tr> </thead> <tbody> <tr><td>0</td><td>3 msec</td><td>6 msec</td></tr> <tr><td>1</td><td>6 msec</td><td>9 msec</td></tr> <tr><td>2</td><td>12 msec</td><td>16 msec</td></tr> <tr><td>3</td><td>24 msec</td><td>28 msec</td></tr> <tr><td>4</td><td>48 msec</td><td>52 msec</td></tr> <tr><td>5</td><td>96 msec</td><td>102 msec</td></tr> <tr><td>6</td><td>192 msec</td><td>202 msec</td></tr> <tr><td>7</td><td>384 msec</td><td>400 msec</td></tr> <tr><td>8</td><td>768 msec</td><td>800 msec</td></tr> <tr><td>9</td><td>1570 msec</td><td>1600 msec</td></tr> </tbody> </table>	Setting	Truth time (Trip after)		min.	max.	0	3 msec	6 msec	1	6 msec	9 msec	2	12 msec	16 msec	3	24 msec	28 msec	4	48 msec	52 msec	5	96 msec	102 msec	6	192 msec	202 msec	7	384 msec	400 msec	8	768 msec	800 msec	9	1570 msec	1600 msec
Setting	Truth time (Trip after)																																				
	min.	max.																																			
0	3 msec	6 msec																																			
1	6 msec	9 msec																																			
2	12 msec	16 msec																																			
3	24 msec	28 msec																																			
4	48 msec	52 msec																																			
5	96 msec	102 msec																																			
6	192 msec	202 msec																																			
7	384 msec	400 msec																																			
8	768 msec	800 msec																																			
9	1570 msec	1600 msec																																			
P11.04 Trip by Voter 2 latched Range: 0 .. 1	Setting 0 : trip by voter 2 is not latched 1 : trip by voter 2 is latched until reset																																				

<p>P11.05 Delay of Antivalence Alarm Range: 0 .. 9</p>	<p>To avoid unnecessary Antivalence Alarms due to shifted trip release signals at the voter inputs a delay may be introduced. Antivalence alarm will then be released only if the time shift between the signals exceeds the set delay.</p> <p>Setting</p> <ul style="list-style-type: none"> 0 : no delay 1 : delay = 100 milliseconds 2 : delay = 500 milliseconds 3 : delay = 1 second 4 : delay = 2 seconds 5 : delay = 3 seconds 6 : delay = 5 seconds 7 : delay = 15 seconds 8 : delay = 30 seconds 9 : delay = 60 seconds <p>Note: The input signals will be monitored for antivalence only, if the voter is active.</p>
<p>P11.06 Setpoint SPV2 Range: 00001 .. 99999 [RPM]</p>	<p>Depending on setting of P11.00, SPV2 controls the activity of voter 2 or controls directly the output LO2. SPV2 is set in terms of RPM.</p>

Parameter Group P12.xx of Monitor E1668 Voter 3 and Logic Output LO3																																					
Parameter No. Meaning of Parameter Setting Range of Parameter	Description of Parameters and their Settings																																				
P12.00 Operation mode Range: 0 .. 5	Setting 0 : Voter inactive 1 : Voter always active (over entire speed range) 2 : Voter only active, if n > SPV3 3 : Voter only active, if n < SPV3 4 : Voter inactive, output LO3 low, if n > SPV3 5 : Voter inactive, output LO3 high, if n > SPV3																																				
P12.01 Input Truth Level Range: 0 .. 1	Setting 0 : high level at inputs is assigned to trip condition 1 : low level at inputs is assigned to trip condition																																				
P12.02 Voting Logic Range: 0 .. 3	Selectable Voting Logics are: <ul style="list-style-type: none"> • 1oo2 : trip is released if 1 of 2 inputs signalizes trip condition • 2oo2 : trip is released if 2 of 2 inputs signalize trip condition • 2oo3 : trip is released if 2 of 3 inputs signalize trip condition • 3oo3 : trip is released if 3 of 3 inputs signalize trip condition Setting 0 : 1oo2 (only inputs 1 and 2 of voter 3 are monitored) 1 : 2oo2 (only inputs 1 and 2 of voter 3 are monitored) 2 : 2oo3 (all three inputs of voter 3 are monitored) 3 : 3oo3 (all three inputs of voter 3 are monitored)																																				
P12.03 Truth Time until Trip Range: 0 .. 7	<p>If the trip signal is shorter than the minimum truth time, the signal is not valid (anti bouncing filter). If the signal is longer than the maximum truth time, the signal is valid and trip is released</p> <p>Note: Signal truth times in between min. and max. may release trip. Maximum response time until trip-lines go to trip status is maximum truth time + 3 milliseconds.</p>	<table border="1"> <thead> <tr> <th rowspan="2">Setting</th> <th colspan="2">Truth time (Trip after)</th> </tr> <tr> <th>min.</th> <th>max.</th> </tr> </thead> <tbody> <tr><td>0</td><td>3 msec</td><td>6 msec</td></tr> <tr><td>1</td><td>6 msec</td><td>9 msec</td></tr> <tr><td>2</td><td>12 msec</td><td>16 msec</td></tr> <tr><td>3</td><td>24 msec</td><td>28 msec</td></tr> <tr><td>4</td><td>48 msec</td><td>52 msec</td></tr> <tr><td>5</td><td>96 msec</td><td>102 msec</td></tr> <tr><td>6</td><td>192 msec</td><td>202 msec</td></tr> <tr><td>7</td><td>384 msec</td><td>400 msec</td></tr> <tr><td>8</td><td>768 msec</td><td>800 msec</td></tr> <tr><td>9</td><td>1570 msec</td><td>1600 msec</td></tr> </tbody> </table>	Setting	Truth time (Trip after)		min.	max.	0	3 msec	6 msec	1	6 msec	9 msec	2	12 msec	16 msec	3	24 msec	28 msec	4	48 msec	52 msec	5	96 msec	102 msec	6	192 msec	202 msec	7	384 msec	400 msec	8	768 msec	800 msec	9	1570 msec	1600 msec
Setting	Truth time (Trip after)																																				
	min.	max.																																			
0	3 msec	6 msec																																			
1	6 msec	9 msec																																			
2	12 msec	16 msec																																			
3	24 msec	28 msec																																			
4	48 msec	52 msec																																			
5	96 msec	102 msec																																			
6	192 msec	202 msec																																			
7	384 msec	400 msec																																			
8	768 msec	800 msec																																			
9	1570 msec	1600 msec																																			
P12.04 Trip by Voter3 latched Range: 0 .. 1	Setting 0 : trip by voter 3 is not latched 1 : trip by voter 3 is latched until reset																																				

<p>P12.05 Delay of Antivalence Alarm Range: 0 .. 9</p>	<p>To avoid unnecessary Antivalence Alarms due to shifted trip release signals at the voter inputs a delay may be introduced. Antivalence alarm will then be released only if the time shift between the signals exceeds the set delay.</p> <p>Setting</p> <ul style="list-style-type: none"> 0 : no delay 1 : delay = 100 milliseconds 2 : delay = 500 milliseconds 3 : delay = 1 second 4 : delay = 2 seconds 5 : delay = 3 seconds 6 : delay = 5 seconds 7 : delay = 15 seconds 8 : delay = 30 seconds 9 : delay = 60 seconds <p>Note: The input signals will be monitored for antivalence only, if the voter is active.</p>
<p>P12.06 Setpoint SPV3 Range: 00001 .. 99999 [RPM]</p>	<p>Depending on setting of P12.00, SPV3 controls the activity of voter 3 or controls directly the output LO3. SPV3 is set in terms of RPM.</p>

Parameter Group P13.xx of Monitor E1668 Voter 4 and Logic Output LO4																																					
Parameter No. Meaning of Parameter Setting Range of Parameter	Description of Parameters and their Settings																																				
P13.00 Operation mode Range: 0 .. 5	Setting 0 : Voter inactive 1 : Voter always active (over entire speed range) 2 : Voter only active, if n > SPV4 3 : Voter only active, if n < SPV4 4 : Voter inactive, output LO4 low, if n > SPV4 5 : Voter inactive, output LO4 high, if n > SPV4																																				
P13.01 Input Truth Level Range: 0 .. 1	Setting 0 : high level at inputs is assigned to trip condition 1 : low level at inputs is assigned to trip condition																																				
P13.02 Voting Logic Range: 0 .. 3	Selectable Voting Logics are: <ul style="list-style-type: none"> • 1oo2 : trip is released if 1 of 2 inputs signalizes trip condition • 2oo2 : trip is released if 2 of 2 inputs signalize trip condition • 2oo3 : trip is released if 2 of 3 inputs signalize trip condition • 3oo3 : trip is released if 3 of 3 inputs signalize trip condition Setting 0 : 1oo2 (only inputs 1 and 2 of voter 4 are monitored) 1 : 2oo2 (only inputs 1 and 2 of voter 4 are monitored) 2 : 2oo3 (all three inputs of voter 4 are monitored) 3 : 3oo3 (all three inputs of voter 4 are monitored)																																				
P13.03 Truth Time until Trip Range: 0 .. 7	<p>If the trip signal is shorter than the minimum truth time, the signal is not valid (anti bouncing filter). If the signal is longer than the maximum truth time, the signal is valid and trip is released</p> <p>Note: Signal truth times in between min. and max. may release trip. Maximum response time until trip-lines go to trip status is maximum truth time + 3 milliseconds.</p>	<table border="1"> <thead> <tr> <th rowspan="2">Setting</th> <th colspan="2">Truth time (Trip after)</th> </tr> <tr> <th>min.</th> <th>max.</th> </tr> </thead> <tbody> <tr><td>0</td><td>3 msec</td><td>6 msec</td></tr> <tr><td>1</td><td>6 msec</td><td>9 msec</td></tr> <tr><td>2</td><td>12 msec</td><td>16 msec</td></tr> <tr><td>3</td><td>24 msec</td><td>28 msec</td></tr> <tr><td>4</td><td>48 msec</td><td>52 msec</td></tr> <tr><td>5</td><td>96 msec</td><td>102 msec</td></tr> <tr><td>6</td><td>192 msec</td><td>202 msec</td></tr> <tr><td>7</td><td>384 msec</td><td>400 msec</td></tr> <tr><td>8</td><td>768 msec</td><td>800 msec</td></tr> <tr><td>9</td><td>1570 msec</td><td>1600 msec</td></tr> </tbody> </table>	Setting	Truth time (Trip after)		min.	max.	0	3 msec	6 msec	1	6 msec	9 msec	2	12 msec	16 msec	3	24 msec	28 msec	4	48 msec	52 msec	5	96 msec	102 msec	6	192 msec	202 msec	7	384 msec	400 msec	8	768 msec	800 msec	9	1570 msec	1600 msec
Setting	Truth time (Trip after)																																				
	min.	max.																																			
0	3 msec	6 msec																																			
1	6 msec	9 msec																																			
2	12 msec	16 msec																																			
3	24 msec	28 msec																																			
4	48 msec	52 msec																																			
5	96 msec	102 msec																																			
6	192 msec	202 msec																																			
7	384 msec	400 msec																																			
8	768 msec	800 msec																																			
9	1570 msec	1600 msec																																			
P13.04 Trip by Voter 4 latched Range: 0 .. 1	Setting 0 : trip by voter 4 is not latched 1 : trip by voter 4 is latched until reset																																				

<p>P13.05 Delay of Antivalence Alarm Range: 0 .. 9</p>	<p>To avoid unnecessary Antivalence Alarms due to shifted trip release signals at the voter inputs a delay may be introduced. Antivalence alarm will then be released only if the time shift between the signals exceeds the set delay.</p> <p>Setting</p> <ul style="list-style-type: none"> 0 : no delay 1 : delay = 100 milliseconds 2 : delay = 500 milliseconds 3 : delay = 1 second 4 : delay = 2 seconds 5 : delay = 3 seconds 6 : delay = 5 seconds 7 : delay = 15 seconds 8 : delay = 30 seconds 9 : delay = 60 seconds <p>Note: The input signals will be monitored for antivalence only, if the voter is active.</p>
<p>P13.06 Setpoint SPV4 Range: 00001 .. 99999 [RPM]</p>	<p>Depending on setting of P13.00, SPV4 controls the activity of voter 4 or controls directly the output LO4. SPV4 is set in terms of RPM.</p>

Parameter Group P14.xx of Monitor E1668 Voter 5 and Logic Output LO5																																					
Parameter No. Meaning of Parameter Setting Range of Parameter	Description of Parameters and their Settings																																				
P14.00 Operation mode Range: 0 .. 5	Setting 0 : Voter inactive 1 : Voter always active (over entire speed range) 2 : Voter only active, if n > SPV5 3 : Voter only active, if n < SPV5 4 : Voter inactive, output LO5 low, if n > SPV5 5 : Voter inactive, output LO5 high, if n > SPV5																																				
P14.01 Input Truth Level Range: 0 .. 1	Setting 0 : high level at inputs is assigned to trip condition 1 : low level at inputs is assigned to trip condition																																				
P14.02 Voting Logic Range: 0 .. 3	Selectable Voting Logics are: <ul style="list-style-type: none"> • 1oo2 : trip is released if 1 of 2 inputs signalizes trip condition • 2oo2 : trip is released if 2 of 2 inputs signalize trip condition • 2oo3 : trip is released if 2 of 3 inputs signalize trip condition • 3oo3 : trip is released if 3 of 3 inputs signalize trip condition Setting 0 : 1oo2 (only inputs 1 and 2 of voter 5 are monitored) 1 : 2oo2 (only inputs 1 and 2 of voter 5 are monitored) 2 : 2oo3 (all three inputs of voter 5 are monitored) 3 : 3oo3 (all three inputs of voter 5 are monitored)																																				
P14.03 Truth Time until Trip Range: 0 .. 7	<p>If the trip signal is shorter than the minimum truth time, the signal is not valid (anti bouncing filter). If the signal is longer than the maximum truth time, the signal is valid and trip is released</p> <p>Note: Signal truth times in between min. and max. may release trip. Maximum response time until trip-lines go to trip status is maximum truth time + 3 milliseconds.</p>	<table border="1"> <thead> <tr> <th rowspan="2">Setting</th> <th colspan="2">Truth time (Trip after)</th> </tr> <tr> <th>min.</th> <th>max.</th> </tr> </thead> <tbody> <tr><td>0</td><td>3 msec</td><td>6 msec</td></tr> <tr><td>1</td><td>6 msec</td><td>9 msec</td></tr> <tr><td>2</td><td>12 msec</td><td>16 msec</td></tr> <tr><td>3</td><td>24 msec</td><td>28 msec</td></tr> <tr><td>4</td><td>48 msec</td><td>52 msec</td></tr> <tr><td>5</td><td>96 msec</td><td>102 msec</td></tr> <tr><td>6</td><td>192 msec</td><td>202 msec</td></tr> <tr><td>7</td><td>384 msec</td><td>400 msec</td></tr> <tr><td>8</td><td>768 msec</td><td>800 msec</td></tr> <tr><td>9</td><td>1570 msec</td><td>1600 msec</td></tr> </tbody> </table>	Setting	Truth time (Trip after)		min.	max.	0	3 msec	6 msec	1	6 msec	9 msec	2	12 msec	16 msec	3	24 msec	28 msec	4	48 msec	52 msec	5	96 msec	102 msec	6	192 msec	202 msec	7	384 msec	400 msec	8	768 msec	800 msec	9	1570 msec	1600 msec
Setting	Truth time (Trip after)																																				
	min.	max.																																			
0	3 msec	6 msec																																			
1	6 msec	9 msec																																			
2	12 msec	16 msec																																			
3	24 msec	28 msec																																			
4	48 msec	52 msec																																			
5	96 msec	102 msec																																			
6	192 msec	202 msec																																			
7	384 msec	400 msec																																			
8	768 msec	800 msec																																			
9	1570 msec	1600 msec																																			
P14.04 Trip by Voter 5 latched Range: 0 .. 1	Setting 0 : trip by voter 5 is not latched 1 : trip by voter 5 is latched until reset																																				

<p>P14.05 Delay of Antivalence Alarm Range: 0 .. 9</p>	<p>To avoid unnecessary Antivalence Alarms due to shifted trip release signals at the voter inputs a delay may be introduced. Antivalence alarm will then be released only if the time shift between the signals exceeds the set delay.</p> <p>Setting</p> <ul style="list-style-type: none"> 0 : no delay 1 : delay = 100 milliseconds 2 : delay = 500 milliseconds 3 : delay = 1 second 4 : delay = 2 seconds 5 : delay = 3 seconds 6 : delay = 5 seconds 7 : delay = 15 seconds 8 : delay = 30 seconds 9 : delay = 60 seconds <p>Note: The input signals will be monitored for antivalence only, if the voter is active.</p>
<p>P14.06 Setpoint SPV5 Range: 00001 .. 99999 [RPM]</p>	<p>Depending on setting of P14.00, SPV5 controls the activity of voter 5 or controls directly the output LO5. SPV5 is set in terms of RPM.</p>

Parameter Group P15.xx of Monitor E1668 Voter 6 and Logic Output LO6																																					
Parameter No. Meaning of Parameter Setting Range of Parameter	Description of Parameters and their Settings																																				
P15.00 Operation mode Range: 0 .. 5	Setting 0 : Voter inactive 1 : Voter always active (over entire speed range) 2 : Voter only active, if n > SPV6 3 : Voter only active, if n < SPV6 4 : Voter inactive, output LO6 low, if n > SPV6 5 : Voter inactive, output LO6 high, if n > SPV6																																				
P15.01 Input Truth Level Range: 0 .. 1	Setting 0 : high level at inputs is assigned to trip condition 1 : low level at inputs is assigned to trip condition																																				
P15.02 Voting Logic Range: 0 .. 3	Selectable Voting Logics are: <ul style="list-style-type: none"> • 1oo2 : trip is released if 1 of 2 inputs signalizes trip condition • 2oo2 : trip is released if 2 of 2 inputs signalize trip condition • 2oo3 : trip is released if 2 of 3 inputs signalize trip condition • 3oo3 : trip is released if 3 of 3 inputs signalize trip condition Setting 0 : 1oo2 (only inputs 1 and 2 of voter 6 are monitored) 1 : 2oo2 (only inputs 1 and 2 of voter 6 are monitored) 2 : 2oo3 (all three inputs of voter 6 are monitored) 3 : 3oo3 (all three inputs of voter 6 are monitored)																																				
P15.03 Truth Time until Trip Range: 0 .. 7	If the trip signal is shorter than the minimum truth time, the signal is not valid (anti bouncing filter). If the signal is longer than the maximum truth time, the signal is valid and trip is released Note: Signal truth times in between min. and max. may release trip. Maximum response time until trip-lines go to trip status is maximum truth time + 3 milliseconds.	<table border="1"> <thead> <tr> <th rowspan="2">Setting</th> <th colspan="2">Truth time (Trip after)</th> </tr> <tr> <th>min.</th> <th>max.</th> </tr> </thead> <tbody> <tr><td>0</td><td>3 msec</td><td>6 msec</td></tr> <tr><td>1</td><td>6 msec</td><td>9 msec</td></tr> <tr><td>2</td><td>12 msec</td><td>16 msec</td></tr> <tr><td>3</td><td>24 msec</td><td>28 msec</td></tr> <tr><td>4</td><td>48 msec</td><td>52 msec</td></tr> <tr><td>5</td><td>96 msec</td><td>102 msec</td></tr> <tr><td>6</td><td>192 msec</td><td>202 msec</td></tr> <tr><td>7</td><td>384 msec</td><td>400 msec</td></tr> <tr><td>8</td><td>768 msec</td><td>800 msec</td></tr> <tr><td>9</td><td>1570 msec</td><td>1600 msec</td></tr> </tbody> </table>	Setting	Truth time (Trip after)		min.	max.	0	3 msec	6 msec	1	6 msec	9 msec	2	12 msec	16 msec	3	24 msec	28 msec	4	48 msec	52 msec	5	96 msec	102 msec	6	192 msec	202 msec	7	384 msec	400 msec	8	768 msec	800 msec	9	1570 msec	1600 msec
Setting	Truth time (Trip after)																																				
	min.	max.																																			
0	3 msec	6 msec																																			
1	6 msec	9 msec																																			
2	12 msec	16 msec																																			
3	24 msec	28 msec																																			
4	48 msec	52 msec																																			
5	96 msec	102 msec																																			
6	192 msec	202 msec																																			
7	384 msec	400 msec																																			
8	768 msec	800 msec																																			
9	1570 msec	1600 msec																																			
P15.04 Trip by Voter 6 latched Range: 0 .. 1	Setting 0 : trip by voter 6 is not latched 1 : trip by voter 6 is latched until reset																																				

<p>P15.05 Delay of Antivalence Alarm Range: 0 .. 9</p>	<p>To avoid unnecessary Antivalence Alarms due to shifted trip release signals at the voter inputs a delay may be introduced. Antivalence alarm will then be released only if the time shift between the signals exceeds the set delay.</p> <p>Setting</p> <ul style="list-style-type: none"> 0 : no delay 1 : delay = 100 milliseconds 2 : delay = 500 milliseconds 3 : delay = 1 second 4 : delay = 2 seconds 5 : delay = 3 seconds 6 : delay = 5 seconds 7 : delay = 15 seconds 8 : delay = 30 seconds 9 : delay = 60 seconds <p>Note: The input signals will be monitored for antivalence only, if the voter is active.</p>
<p>P15.06 Setpoint SPV6 Range: 00001 .. 99999 [RPM]</p>	<p>Depending on setting of P15.00, SPV6 controls the activity of voter 6 or controls directly the output LO6. SPV6 is set in terms of RPM.</p>

Parameter Group P16.xx of Monitor E1668 Reserved for future application	
Parameter No. Meaning of Parameter Setting Range of Parameter	Description of Parameters and their Settings
P16.00 Reserved for future application	
P16.01 Reserved for future application	
P16.02 Reserved for future application	
P16.03 Reserved for future application	
P16.04 Reserved for future application	
P16.05 Reserved for future application	
P16.06 Reserved for future application	

Parameter Group P17.xx of Monitor E1668 PROFIBUS	
Parameter No. Meaning of Parameter Setting Range of Parameter	Description of Parameters and their Settings
P17.00 Device No for PROFIBUS Range: 001 .. 125	All members of the PROFIBUS-Communication must have different device nos.
P17.01 Address Offset for redundant PROFIBUS Interface Range: 0 .. 9	For test purposes (operation of both PROFIBUS Interfaces at the same Bus) an address offset may be introduced for the redundant (right one on front panel) PROFIBUS Interface. Example: With P17.00 = 34 und P17.01 = 4 the right hand side PROFIBUS Interface has adress 38.

9. This chapter is left blank intentionally

10. Event codes and Troubleshooting

10.1. Event Codes on display of E1668

The Event Codes are shown in format E.0.x.x.x .
Depending on setting of P02.11 only the first occurred fault or all faults are displayed (combination of faults is possible).

Display	Explanation of Event Code
E.0.0.0.0	Overspeed trip (if P03.02 = 0)
E.0.x.x.1	Sensor failure (current or voltage), refer to P02.05
E.0.x.x.2	Deviation of primary sensor versus neighbor sensors, refer to P02.07
E.0.x.x.3	E.x.x.x.1 + E.x.x.x.2
E.0.x.x.4	Speed < SP2
E.0.x.x.5	E.x.x.x.1 + E.x.x.x.4
E.0.x.x.6	E.x.x.x.2 + E.x.x.x.4
E.0.x.x.7	E.x.x.x.1 + E.x.x.x.2 + E.x.x.x.4
E.0.x.1.x	Generator tests with zero speed
E.0.x.2.x	Trip by Voter
E.0.x.4.x	Internal relay fault
E.0.1.x.x	Failure detection during internal self test
E.0.2.x.x	Overspeed trip (if P03.02 = 1)
E.0.3.x.x	E.x.1.x.x + E.x.2.x.x
E.0.4.0.0 without Trip	Alarm caused by missing external signals (Trip-Lines) (for troubleshooting refer to next page)
E.0.4.0.0 with Trip	Trip-Line Monitoring has caused trip
E.0.4.2.0	Trip by voter (with non-coincidence at inputs of voter)
E.0.6.x.x	E.x.2.x.x + E.x.4.x.x
E.0.8.0.0	Trip-Line Monitoring has caused trip
E.0.A.0.0	Trip due to Overspeed (and P07.00 = 1 or 3)
E.0.c.0.0	Trip-Line Monitoring has caused trip plus antivalence of signals for Trip-Line-Monitoring (for troubleshooting refer to next page)
E.3.0.1.0	Starter Input is active at speed > 50% of SP1A (only if P02.06 = 1 or 2)
E.3.0.2.0	External Analog output error ('no load' or fault of connected device)
E.3.0.2.1	Internal Analog output error (fault on monitor board)
-E1-	Wrong code figure in step P00.00

10.2. Troubleshooting if display of Monitor reads E.0.4.x.x

Display E.0.4.x.x signalizes a fault (not all signals are identical) from the input signals for the voters or for Trip-Line-Monitoring (resp. feedbacks from 2oo3-solenoid).
The actual status of the signal inputs is shown in Special Display Mode 2.

Switching between Standard and Special Display Mode 2 by pressing keys Δ and \square together.

Special Display Mode 2

In Special Display Mode 2 LED1 and LED4 are blinking.

Steps of Special Display Mode 2 :

- 0._x.x.x
- 1._x.x.x
- 2._x.x.x
- 3._x.x.x
- 4._x.x.x

Steps of Special Display Mode 2 are selected with key Δ (next step) resp. key ∇ (previous step).

For troubleshooting only steps 3._x.x.x and 4._x.x.x are relevant.

The status of signal inputs for Trip-Line-Monitoring are shown in step 3 .
Display of:

- 3._x.x.1 : Feedback signal from Trip-Line I is true
- 3._x.x.2 : Feedback signal from Trip-Line II is true
- 3._x.x.4 : Feedback signal from Trip-Line III is true

resp. all combinations hereof, for example:

- 3._x.x.7 : all Feedback signal from Trip-Lines are true

The voter signal inputs are shown in step 4._x.x.x

Display of:

- 4.n.0.0.1 : Voter n, input 1 active n = 1 - 6 (7 reserved)
- 4.n.0.0.2 : Voter n, input 2 active
- 4.n.0.0.4 : Voter n, input 3 active

resp. all combinations hereof, for example:

- 4.3.0.0.5 : Voter 3, inputs 1 und 3 active, input 2 not active.

While key \square is pressed, the input status latched at error will be shown, else the current input status.

Switch the input status of voter 1 to 6 with key \square .

11. Revision notes

Date	Rev.	Modification
19.06.2014	00	Initial release
24.09.2015	01	<p>Editorial modification only: Terminal nos modified from leading no to trailing no, for example: 1.X1 is now X01.1 5.X14 is now X14.5</p> <p>Technical and editorial modification: valid for Monitors E1668 exceeding serial no 1508270018 with firmware state A.0383 (firmware ID) U._ _00 (00 = firmware version number) D.18_ _ (15 = day) D._05_ (08 = month) D._ _15 (ww = year of firmware release state)</p> <p>resp. E16x352-systems with serial no exceeding 1508270016:</p> <ul style="list-style-type: none"> • Tighter timing for "Truth Time until Trip" and additional settings 8 and 9 of voters 1 through 6, see steps P10.03 through P15.03